

Grandstream Networks, Inc.

DP750/DP720

Administration Guide



COPYRIGHT

©2016 Grandstream Networks, Inc. <http://www.grandstream.com>

All rights reserved. Information in this document is subject to change without notice. Reproduction or transmittal of the entire or any part, in any form or by any means, electronic or print, for any purpose without the express written permission of Grandstream Networks, Inc. is not permitted.

The latest electronic version of this guide is available for download here:

<http://www.grandstream.com/support>

Grandstream is a registered trademark and Grandstream logo is trademark of Grandstream Networks, Inc. in the United States, Europe and other countries.

CAUTION

Changes or modifications to this product not expressly approved by Grandstream, or operation of this product in any way other than as detailed by this guide, could void your manufacturer warranty.

WARNING

Please do not use a different power adaptor with devices as it may cause damage to the products and void the manufacturer warranty.



GNU GPL INFORMATION

DP750 firmware contains third-party software licensed under the GNU General Public License (GPL). Grandstream uses software under the specific terms of the GPL. Please see the GNU General Public License (GPL) for the exact terms and conditions of the license.

Grandstream GNU GPL related source code can be downloaded from Grandstream web site from:

http://www.grandstream.com/sites/default/files/Resources/gpl_dp750.tar.gz



Table of Contents

DOCUMENT PURPOSE	9
CHANGE LOG	10
Firmware Version 1.0.2.16	10
Firmware Version 1.0.1.14	10
Firmware Version 1.0.1.4	10
Firmware Version 1.0.0.16	11
GUI INTERFACE EXAMPLES	12
WELCOME	13
PRODUCT OVERVIEW	14
Feature Highlights	14
DP750 Technical Specifications	15
DP720 Technical Specifications	16
GETTING STARTED	18
Equipment Packaging	18
Connecting DP750	19
<i>Connecting via AC power</i>	19
<i>Connecting via PoE</i>	20
Setting up DP720 handset	20
<i>Battery Information</i>	20
Setting up the Charge Station	21
DP750 LED Patterns	21
DP720 Handset Description	22
DP720 Icons Description	24
DP720 Handset Menu	26
CONFIGURATION GUIDE	29
Obtain DP750 Base Station IP Address via paired DP720	29
Configuration via Web Browser	30
<i>Accessing the Web UI</i>	30
<i>Saving the Configuration Changes</i>	30
Web UI Access Level Management	30
<i>Changing User Level Password</i>	31
<i>Changing Admin Level Password</i>	31



<i>Changing HTTP / HTTPS Web Access Port</i>	32
Web Configuration Definitions	33
<i>Status Page Definitions</i>	33
<i>Profiles Page Definitions</i>	36
<i>DECT Page Definitions</i>	45
<i>Settings Page Definitions</i>	46
<i>Maintenance Page Definitions</i>	48
<i>Phonebook Page Definitions</i>	55
Change Base Station Admin PIN code	58
Register DP720 Handset to DP750 Base Station	58
Using DP720 with Multiple DP750 Base Stations	59
<i>Registering DP720 to an additional DP750 base station</i>	60
<i>Switching Between Different Base Stations</i>	60
Unregister the DP720	61
Locating a DP720 Handset from DP750 Base station.....	61
<i>Locate via DP750 Web UI</i>	61
<i>Locate via DP750 Base station</i>	62
Register a SIP Account	62
<i>Register account via web user interface</i>	62
Multiple Lines and Hunting Groups.....	65
<i>Handset Line Settings</i>	65
<i>Outgoing Default Line</i>	66
<i>Hunting Groups</i>	66
Configuration via Keypad.....	70
Call Features.....	71
DP750 Phonebook Management.....	72
<i>Private Phonebook</i>	72
<i>Global Phonebook</i>	75
<i>Global Phonebook via XML</i>	75
<i>Global Phonebook via LDAP</i>	79
Rebooting from Remote Location	80
UPGRADING AND PROVISIONING	81
Firmware Upgrade procedure	81
Upgrading via Local TFTP/HTTP Servers	82
Upgrading DP720 handset	83
Configuration File Download.....	84
RESTORE FACTORY DEFAULT SETTINGS	85
Resetting the DP720 Handset	85
Resetting the DP750 Base Station	85



Via Reset Button 85

Via Web GUI 85

EXPERIENCING DP750/720 **86**



Table of Tables

Table 1: DP750 Features in a Glance	14
Table 2: DP720 Features in a Glance	14
Table 3: DP750 Technical Specifications	15
Table 4: DP720 Technical Specifications	16
Table 5: Equipment Packaging	18
Table 6: DP750 LED Patterns	21
Table 7: Keypad Keys Description	23
Table 8: DP720 Icons Description	24
Table 9: Status Page Definitions	33
Table 10: Profiles Page Definitions	36
Table 11: DECT Page Definitions	45
Table 12: Settings Page Definitions	46
Table 13: Maintenance Page Definitions.....	48
Table 14: Phonebook Page Definitions	55
Table 15: Call Features	71



Table of Figures

Figure 1: DP750 Package Content	18
Figure 2: DP720 Package Content	18
Figure 3: DP750 Back View	19
Figure 4: Connecting the Base station	20
Figure 5: Setting up the DP720.....	20
Figure 6: Setting up the charge station	21
Figure 7: Handset Keys Description	23
Figure 8: DP720 Menu Structure	26
Figure 9: User Level Password	31
Figure 10: Admin Level Password	32
Figure 11: Web Access Port.....	33
Figure 12: Admin PIN Code	58
Figure 13: DECT Status – Subscribe.....	58
Figure 14: Registration Process.....	59
Figure 15: Multiple Base Stations Registration	60
Figure 16: Switching Between Base Stations	61
Figure 17: Locate Handset via Web UI	62
Figure 18: SIP Settings	63
Figure 19: Sip Accounts Settings	64
Figure 20: Account Status	64
Figure 21: Handset Line Settings.....	65
Figure 22: Account Status – Line Status	66
Figure 23: Hunting Group configuration.....	69
Figure 24: Hunting Group Status	69
Figure 25: Private Phonebook Settings	73
Figure 26: Handset Phonebook Settings	74
Figure 27: Handset Phonebook Selection	74
Figure 28: Global Phonebook XML Settings.....	75
Figure 29: Automatic XML Phonebook Download	76
Figure 30: Manual XML Phonebook Management	77
Figure 31: Global Phonebook LDAP Settings.....	79
Figure 32: Firmware Upgrade Page.....	82
Figure 33: Handset Firmware Upgrade.....	83



DOCUMENT PURPOSE

This document describes how to configure DP750 Base Station features via DP720 Handset LCD menu and Web GUI menu. The intended audiences of this document are VOIP administrators. To learn the basic functions of DP750/DP720, please visit <http://www.grandstream.com/support> to download the latest “DP750/DP720 User Guide”.

This guide covers following topics:

- [Product Overview](#)
- [Getting Started](#)
- [Configuration Guide](#)
- [Upgrading and provisioning](#)
- [Restore factory default settings.](#)



CHANGE LOG

This section documents significant changes from previous versions of administration guide for DP750/DP720. Only major new features or major document updates are listed here. Minor updates for corrections or editing are not documented here.

Firmware Version 1.0.2.16

- Added TR-069 CPE support. [TR-069]
- Added Repeater mode support at DECT > General Settings. [Enable Repeater Mode]
- Added support of plus button '+' when dialing. [Dial Plan]
- Added "Verify host when using HTTPS" option at Maintenance > Firmware Upgrade. [Verify host when using HTTPS]
- Added status displays as "Normal" when core dump list is empty. [Core Dump]
- Added "Access Control Lists" at Maintenance > Web/SSH Access. [Access Control Lists]
- Added support for HTTPS web access. [HTTPS Web Port][HTTP / HTTPS Web Port]
- Changed menu "Line Status" in Call Settings to "Lines". [Lines]
- Improved DNS Settings page. [Network Settings – Basic Settings]
- Re-arranged the Setting Status menu. [DP720 Handset Menu]
- Add documents and drilling templates to web GUI support page. [Support]
- Web UI Enhancements
- Added Serbian, Slovakian languages.
- Improved support for Czech, Dutch, German, Hebrew, Japanese, Korean, Turkish languages.

Firmware Version 1.0.1.14

- Removed IVR (Interactive Voice Response).
- Hide the content of "Advanced Settings" page when accessing the web GUI with normal user. [Web UI Access Level Management]
- Added voice mail, missed calls, headset icons. [DP720 Icons Description]
- Moved Download Config options to Provisioning page. [Provisioning]
- Added Dialing box controls for off-hook dialing on DECT > General Settings. [General Settings]
- Changed EU standard ring tog tone same as US. [Ring Tones]
- Added support for configurable system ring tone on Settings > Ring Tones. [Ring Tones]
- Added web UI support for packet capture on Maintenance > Packet Capture [Packet Capture].
- Removed "Internal call" from audio ring tone menu.
- Removed "Intercom" feature completely.

Firmware Version 1.0.1.4

- Added dialing box controls for off-hook dialing on Profile > Call Settings.
- Added Reset handset name to default if handset is unsubscribed.
- Added DHCPv4 Option 120 on Maintenance > Provisioning. [Provisioning]



- Move Network Settings and Phonebook tabs. [Network Settings] [Phonebook]
- Added handset version (firmware) on Status > System Status.
- Web UI Status Enhancements.
- Changed location of handset firmware upload/delete.
- Improved web UI Account Status page.
- Added processing of DHCP option 160 by DHCP client.
- Added support to receive a handset proprietary message when handset power off.
- Added "Off-Hook Auto-Dial " option on DECT -> General Settings. [Off-hook Auto-dial]
- Added support to upload handset firmware from web UI. [Handset Firmware]
- Added delete button for uploaded handset firmware via web UI. [Handset Firmware]

Firmware Version 1.0.0.16

- This is the initial version for DP750/DP720.



GUI INTERFACE EXAMPLES

http://www.grandstream.com/sites/default/files/Resources/dp750_web_gui.zip

1. Screenshot of Login Page
2. Screenshots of Status Pages
3. Screenshots of Profiles Pages
4. Screenshots of DECT Pages
5. Screenshots of Phonebook Pages
6. Screenshots of Settings Pages
7. Screenshots of Maintenance Pages



WELCOME

Thank you for purchasing Grandstream DP750 DECT IP Base Station. DP750 is the next generation of versatile, affordable, high quality and simple to use DECT IP Base Station for small-to-medium businesses (SMBs) and residential users. This Linux-based model allows up to 5 registered DECT handsets and up to 4 concurrent calls simultaneously. It features compact size, superb HD audio quality, rich feature set, market leading price-performance and wide range radio coverage which allow users to enjoy the benefits of mobility and voice-over-IP for a minimum investment. DP750 is fully compliant with SIP/DECT standard and field proven for flexible deployment.



PRODUCT OVERVIEW

Feature Highlights

The following tables contain the major features of the DP750 / DP720:

<p style="text-align: center;">DP750</p> 	<ul style="list-style-type: none"> • 5 handsets. • 10 accounts. • 10 Lines. • 4 Concurrent calls. • PoE power support. • 300m range outdoor / 50m range indoor.
---	---

Table 1: DP750 Features in a Glance

<p style="text-align: center;">DP720</p> 	<ul style="list-style-type: none"> • DECT Cordless HD. • 1.8 inch (128x160) TFT color LCD. • 250 hours standby / 20 hours talk time. • 15 languages embedded. • 10 accounts. • 10 lines. • 5 ring modes.
---	---

Table 2: DP720 Features in a Glance

DP750 Technical Specifications

The following table resumes all the technical specifications including the protocols / standards supported, voice codecs, telephony features, languages and upgrade/provisioning settings for the Base station DP750.

Table 3: DP750 Technical Specifications

Air Interface	Telephony standards: DECT Frequency bands: <ul style="list-style-type: none"> ▪ 1880 – 1900 MHz (Europe), 1920 – 1930 MHz (US) ▪ 1910 – 1920 MHz (Brazil), 1786 – 1792 MHz (Korea) ▪ 1893 – 1906 MHz (Japan), 1880 – 1895 MHz (Taiwan) Number of channels: 10 (Europe), 5 (US, Brazil or Japan), 3 (Korea), 8 (Taiwan) Range: up to 300 meters outdoor and 50 meters indoor
Peripherals	5 LED indicators: Power, Network, Register, Call, DECT Reset button, Pairing/Paging button One 10/100 Mbps auto-sensing Ethernet port with integrated PoE
Protocols/Standards	SIP RFC3261, TCP/IP/UDP, RTP/RTCP, HTTP, ARP/RARP, ICMP, DNS (A record, SRV, NAPTR), DHCP, PPPoE, SSH, TFTP, NTP, STUN, SIMPLE, LLDP-MED, LDAP, TR-069, 802.1x, TLS, SRTP, IPv6 (pending)
Voice Codecs	G.711 μ /a-law, G.723.1, G.729A/B, G.726-32, iLBC, G.722, OPUS, G.722.2/AMR-WB (special order), in-band and out-of-band DTMF (in audio, RFC2833, SIP INFO), VAD, CNG, PLC, AJB
Telephony Features	Hold, transfer, forward, 3-way conference, downloadable phonebook (XML, LDAP, up to 3000 entries), call waiting, call log (up to 300 records), auto answer, flexible dial plan, music on hold, server redundancy and fail-over
Sample Applications	Currency (pending)
QoS	Layer 2 QoS (802.1Q, 802.1p) and Layer 3 QoS (ToS, DiffServ, MPLS)
Security	User and administrator level access control, MD5 and MD5-sess based authentication, 256-bit AES encrypted configuration file, TLS, SRTP, HTTPS, 802.1x media access control, DECT authentication & encryption
Multi-language	English, Czech, German, Spanish, French, Hebrew, Nederlands, Japanese, Chinese Simple, Chinese Tradition, Korean, Portuguese, Slovakian, Serbian, Turkish.
Upgrade/Provisioning	Firmware upgrade via TFTP/HTTP/HTTPS, mass provisioning using TR-069 or AES encrypted XML configuration file
Multiple SIP Accounts	Up to ten (10) distinct SIP accounts per system Each handset may map to any SIP account(s) Each SIP account may map to any handset(s)
Ring Group	Flexible options when multiple handsets share the same SIP account



	<ul style="list-style-type: none"> ▪ Circular Mode: all phones ring sequentially, starting with the phone after the one which rang last. ▪ Linear Mode: all phones ring sequentially in the predetermined order, starting with the first phone each time. ▪ Parallel Mode: all phones ring concurrently; after one phone answers, the remaining available phones can make new calls ▪ Shared Mode: all phones ring concurrently and always share the same line (similar to analog phones).
Power & Green Energy Efficiency	Universal Power Supply Input AC 100-240V 50/60Hz; Output 5VDC, 1A; Micro-USB connection; PoE: IEEE802.3af Class 1, 0.44W–3.84W
Package Content	Base unit, Universal Power Supply, Ethernet cable, Quick Start Guide, GPL Statement
Dimensions	28.5 mm (H) x 130 mm (W) x 90 mm (D)
Weight	Base unit: 143g, Universal Power Supply: 50g; Package: 360g
Temperature and Humidity	Operation: -10° to 55°C (14 to 131°F); Storage: -20° to 60°C (-4 to 140°F); Humidity: 10% to 90% non-condensing
Compliance	FCC: Part 15D, 47 CFR 2.1093, Part 15B CE: EN60950; EN301489-1-6; EN301406 RCM: AS/NZS60950 (Pending)

DP720 Technical Specifications

The following table resumes all the technical specifications including the protocols / standards supported, voice codecs, telephony features, languages and upgrade/provisioning settings for the DP720 handset.

Table 4: DP720 Technical Specifications

Air Interface	Telephony standards: DECT Frequency bands: <ul style="list-style-type: none"> ▪ 1880 – 1900 MHz (Europe), 1920 – 1930 MHz (US) ▪ 1910 – 1920 MHz (Brazil), 1786 – 1792 MHz (Korea) ▪ 1893 – 1906 MHz (Japan), 1880 – 1895 MHz (Taiwan) Number of channels: 10 (Europe), 5 (US, Brazil or Japan), 3 (Korea), 8 (Taiwan) Range: up to 300 meters outdoor and 50 meters indoor
Peripherals	1.8 inch (128x160) color TFT LCD 23 keys including 2 softkeys, 5 navigation / menu keys, 4 dedicated function keys for SEND, POWER/END, SPEAKERPHONE, MUTE 3-color MWI LED 3.5mm headset jack Removable belt clip Micro-USB port for alternative charging and non-battery operation
Protocols/Standards	Hearing Aid Compatibility (HAC) compliant



Voice Codecs	G.722 codec for HD audio and G.726 codec for narrow band audio (G.711 μ -law, G.723.1, G.729A/B, iLBC and OPUS are supported via companion DECT base station DP750), AEC, AGC, Ambient noise reduction
Telephony Features	Hold, transfer, forward, 3-way conference, call park, call pickup, downloadable phonebook, call waiting, call log, auto answer, click-to-dial, flexible dial plan, music on hold
Sample Applications	Currency (pending)
HD Audio	Yes, in both Handset and Speakerphone modes
Security	DECT authentication & encryption
Multi-language	English, Czech, German, Spanish, French, Hebrew, Nederlands, Japanese, Chinese Simple, Chinese Tradition, Korean, Portuguese, Slovakian, Serbian, Turkish.
Upgrade/ Provisioning	Software Upgrade Over-The-Air (SUOTA), handset provisioning Over-The-Air
Multiple Line Access	Each handset may access up to 10 lines
Power & Green Energy Efficiency	Universal Power Supply Input AC 100-240V 50/60Hz; Output 5VDC 1A; Micro-USB connection; Rechargeable 800mAh Ni-MH Low Self-Discharge (LSD) AAA batteries (250 hours of standby time and 20 hours of talk time)
Package Content	Handset unit, universal power supply, charger cradle, belt clip, 2 batteries, Quick Start Guide
Dimensions (H x W x D)	Handset: 155 x 50 x 26 mm, charger cradle: 35 x 63.5 x 54 mm
Weight	Handset: 138g, charger cradle: 71g, universal power supply: 50g; Package: 360g
Temperature and Humidity	Operation: -10 $^{\circ}$ to 50 $^{\circ}$ C (14 to 122 $^{\circ}$ F); Charging: 0 to 45 $^{\circ}$ C (32 to 113 $^{\circ}$ F); Storage: -20 $^{\circ}$ to 60 $^{\circ}$ C (-4 to 140 $^{\circ}$ F); Humidity: 10% to 90% non-condensing
Compliance	FCC: Part 15D; 47 CFR 2.1093 & IEEE1528-2013, Part68, Part 15B CE: EN60950; EN301489-1-6; EN301406; EN50360; EN62209-1 RCM: AS/NZS60950; AS/ACIF S040; AS/ACIF S004; AS/CA S004:2013 (Pending)



GETTING STARTED

This chapter provides basic installation instructions including the list of the packaging contents and also information for obtaining the best performance with the DP720 IP DECT phone and its Base station DP750.

Equipment Packaging

Table 5: Equipment Packaging

DP720	DP750
<ul style="list-style-type: none"> • 1 Handset unit • 1 Universal power supply 5V • 1 Charger cradle • 1 Belt clip • 2 Rechargeable batteries • 1 Quick Start Guide 	<ul style="list-style-type: none"> • 1 Base unit • 1 Universal power supply 5V • 1 Ethernet cable • 1 Quick Start Guide • 1 GPL Statement

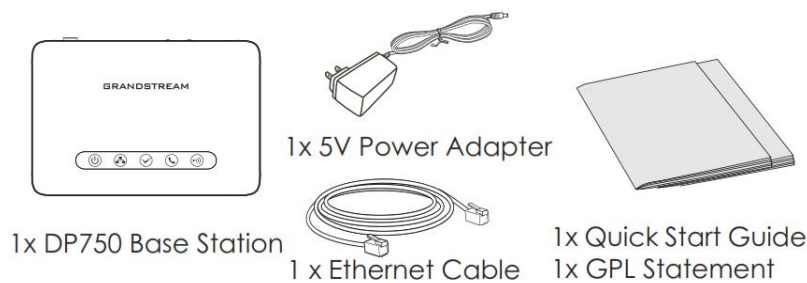

Figure 1: DP750 Package Content

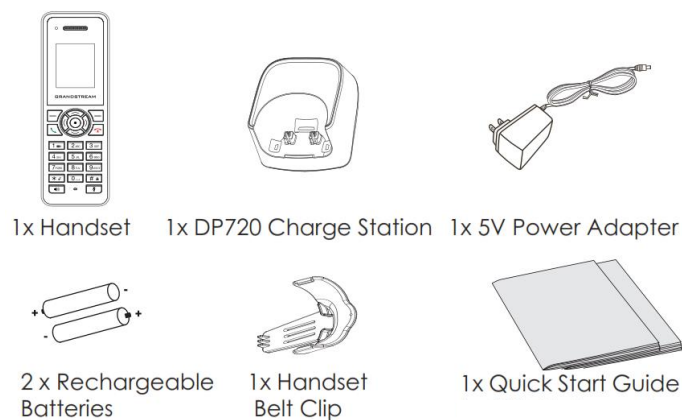

Figure 2: DP720 Package Content

Note: Check the package before installation. If you find anything missing, contact your system administrator.

Connecting DP750

To setup the DP750 Base Station, please follow the steps below:

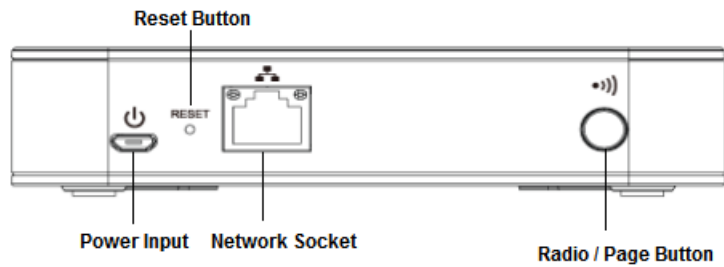

Figure 3: DP750 Back View

You have two options for power and network connection of the base station: AC power or Power over Ethernet (PoE)

Connecting via AC power

1. Connect the micro-USB connector into the related port on the base station and connect the other end of the power adapter into an electrical power outlet.
2. Connect the supplied Ethernet cable between the Internet port on the base station and the Internet port in your network or the switch/hub device port.

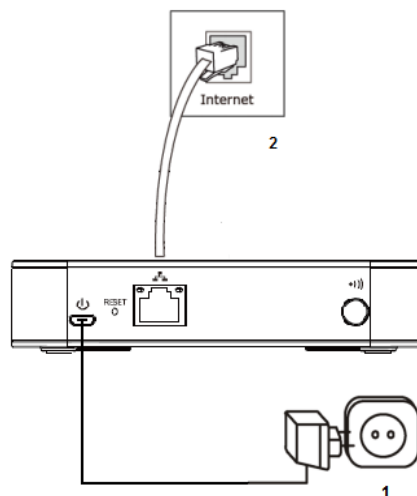

Figure 4: Connecting the Base station

Connecting via PoE

To connect the base station using PoE, you need to connect the Ethernet cable provided (or 3rd party network cable) between the Network Socket on the base station to Ethernet port of your PoE switch/hub.

Setting up DP720 handset

Please follow below steps to insert batteries into the handset:

1. Open the battery compartment cover.
2. Insert the batteries in the correct polarity.
3. Close the battery compartment cover.

Note: Please charge the batteries fully before using the handset for the first time

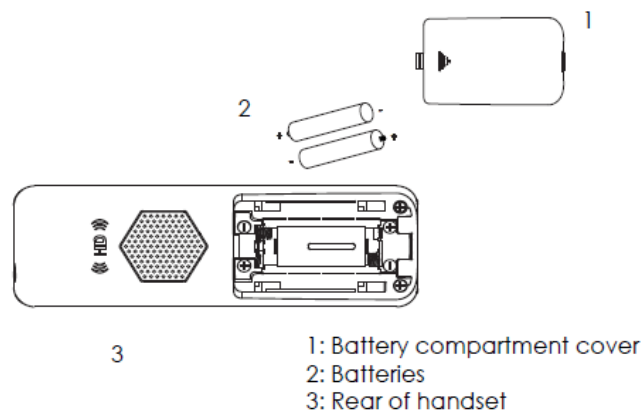

Figure 5: Setting up the DP720

Battery Information

- **Technology:** Nickel Metal Hydride (Ni-MH)
- **Size:** AAA
- **Voltage:** 1.2V
- **Capacity:** 800mAh
- **Charging time:** 12 hours from empty to full
- **Standby time:** up to 250 hours
- **Talk time:** up to 20 hours active talk time

In order to get the best performance of your DP720 handset, we recommend using original batteries provided in the package or batteries compliant with above specifications.

The specifications may differ depending on the age and capacity of the batteries used.

Important Note: Be careful when inserting the batteries into your handset to avoid any risk of short-circuit, which lead to damage your batteries and/or the handset itself. Do not use damaged batteries which can increase the risk of serious harm.

Setting up the Charge Station

Please refer to the following steps for setting up the charge station and charging the handset:

1. Connect the DC plug on the power adapter to the micro-USB connector on the charge station.
2. Connect the other end of the power adapter into an electrical power outlet.
3. After setting up the handset and the charge station, place the handset in the charge station.

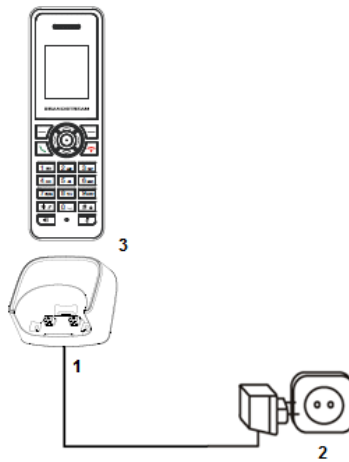





Figure 6: Setting up the charge station



DP750 LED Patterns

The DP750 has 5 LED lights on it. Please refer to the following table for the meaning of each light.



Table 6: DP750 LED Patterns

LED Light	Status
	Indicates Power ON/OFF.
	Indicates access to the network. Remains ON while there is access to the network.
	Indicates if a SIP account is registered.

	Indicates status of the lines. Blinking: A line is in use. Solid ON: All lines are free.
	The Radio icon for pairing the DP720 and DP750; when holding the Radio button, blinking indicates a pairing attempt.

DP720 Handset Description

The LCD screen and the Keypad are the main hardware components of the DP720.



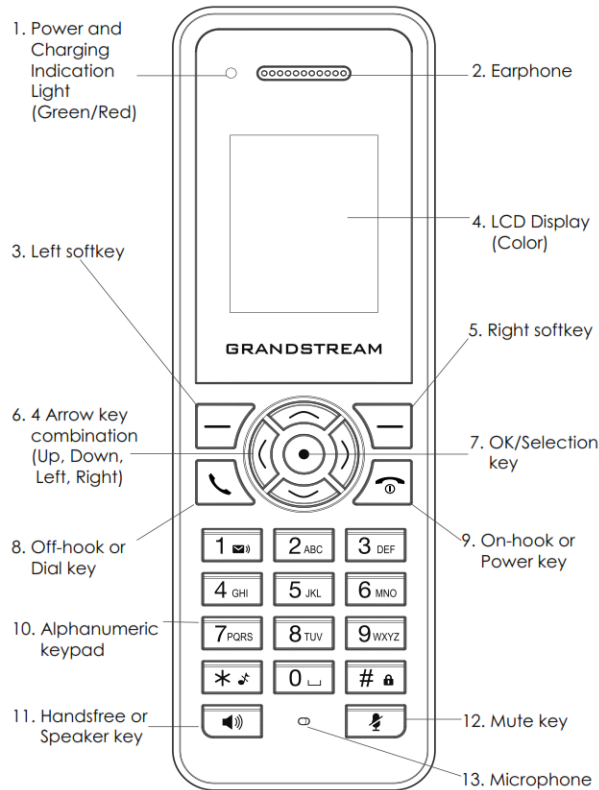

Figure 7: Handset Keys Description

Table 7: Keypad Keys Description













	Key	Description
1.	Power and Charging Indication Light	Red: Charging. Green: Charge completed. Blinking: Missed call(s) or Voice Mail received.
2.	Earphone	Delivers audio output.
3,5	Left and Right softkeys	Correspond to functions displayed on the LCD. These functions change depending on the current context.
4.	LCD Display	Shows call information, handset status icons, prompt messages, etc.
6.	4 Arrow key combination	Permits navigation of the cursor through the displayed menu options.
7.	OK/Selection key	Selects the option chosen by the cursor. (Enters the main menu from the home screen.)
8.	Off-hook / Dial key	Enters dialing mode, or dials number entered.
9.	On-hook / Power key	Terminates calls, or turns the handset on / off.
10.	Alphanumeric Keypad	Provides the digits, letters, and special characters in context-sensitive applications. For + sign, press and hold key 0.
11.	Hands-free / Speaker key	Switches between Handset and Hands-free / Speaker modes.
12.	Mute key	Activates or Deactivates the Mute feature.
13.	Microphone	Picks up audio earpiece and hands-free calls.





















DP720 Icons Description

The following table contains description of each icon that might be displayed on the screen of your DP720.

Table 8: DP720 Icons Description

	Alarm Alarm icon. The icon shows when set alarm.
	Snooze Snooze icon. The icon shows when set snooze.
	Battery status Not equipped with battery
	Battery status Battery empty
	Battery status Battery low
	Battery status Battery normal
	Battery status Battery full
	Battery status Charging
	Signal status Not subscribed
	Signal status Not in range
	Signal status Signal very low
	Signal status Signal low
	Signal status Signal normal
	Signal status Signal good
	Signal status Signal very good

	Microphone MUTE Status OFF - Not muted ON – Muted
	Speaker status OFF - Speaker is inactivated ON - Speaker is activated
	Headset icon
	Missed Call icon
	Voicemail icon
	Ringtone status OFF - Ringtone off (Silent mode) ON - Ringtone on
	Keypad Lock status OFF - Keypad unlock ON - Keypad locked
	Incoming Call notification
	Outgoing Call notification
	Missed Call notification
	Incoming Call notification
	Outgoing Call notification
	Voicemail notification
	Contacts
	Call History
	Voice Mail
	Settings
	Call Settings
	Tools

DP720 Handset Menu

The handset has an easy-to-use menu structure. Every menu opens a list of options. To open the main menu, press “Menu” (left softkey) when the handset is on and in standby mode. Press Arrow keys to navigate to the menu option you require. Then press “Select” (left softkey) or **OK/Selection key** to access further options or confirm the setting displayed. To go to the previous menu item, press “Back” (right softkey). You can press **Power** key at any time to cancel and return to standby mode. If you do not press any key, the handset automatically reverts to standby mode after 20 seconds.

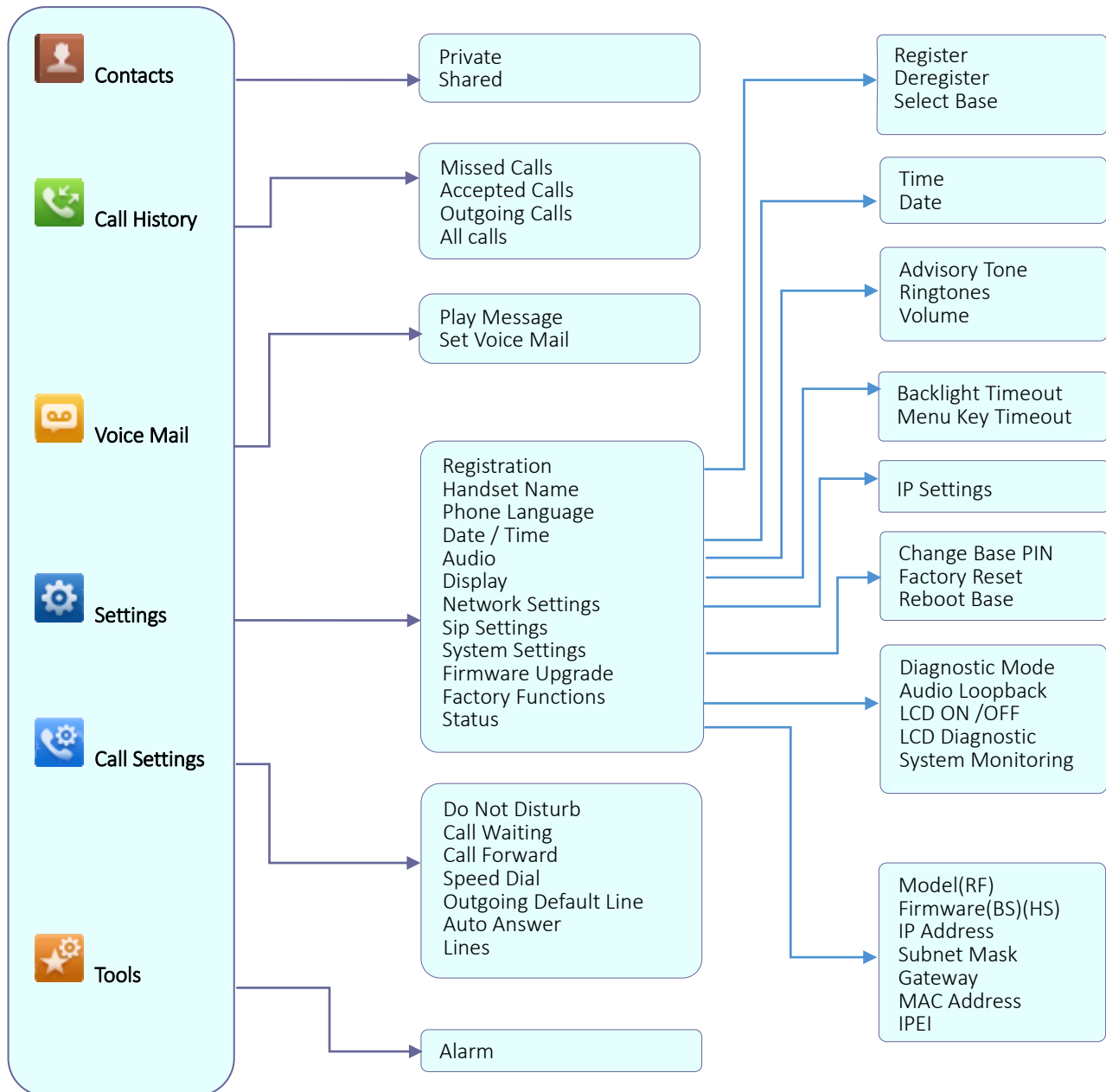

Figure 8: DP720 Menu Structure



Contacts	<ul style="list-style-type: none"> • Private: Private contacts include contacts visible in the current handset only. You can add, edit, delete, and call all the entries in private contacts. • Shared: Shared contacts are the contacts shared between the handsets subscribed to the DP750 base station. You can add, edit, delete, edit and call all the entries in shared contacts as well.
Call History	Display the call history: Missed Calls , Accepted Calls , Outgoing Calls or All Calls . You can add contacts to Shared Contacts directly from call logs.
Voice Mail	<ul style="list-style-type: none"> • Play Message: Play voice mail messages received. • Set Voice Mail: Configure voice mail parameters.
Settings	<ul style="list-style-type: none"> • Registration Register and unregister your handset and also search for base station. • Handset Name Change the handset's name. • Phone Language Select the language to be displayed on the phone's LCD. (Default is English.) • Date/Time Configure date and time on the Handset. • Audio Specify ringtones for internal/external calls, the volume, and advisory tones (Keypad, Confirmation, Low battery notifications). • Display Configure backlight and menu key timeout. • Network Settings Configure IP addresses and select DHCP/Static IP mode. • SIP Settings Configure/View SIP accounts settings. • System settings Change Base PIN code; perform factory reset. • Firmware Upgrade Upgrade the firmware version of the handset. • Factory Functions <ul style="list-style-type: none"> - <i>Diagnostic Mode</i> All LEDs will light up, and the LCD will display a table listing the names of all keys in red. Press any key to diagnose; the key's name will display in blue. After all keys are diagnosed, a prompt message ("PASS") will display; press "Back" (right softkey) to exit. - <i>Audio Loopback</i> Speak to the phone using speaker/handset/headset. If you can hear your voice, your audio is working fine. Press "Exit" softkey to exit audio loopback mode.



	<ul style="list-style-type: none"> - <i>LCD ON / OFF</i> Select this option to turn off LCD. Press any button to turn on LCD. - <i>LCD Diagnostic</i> Select this option to enter LCD Diagnostic mode. Press "Next" (left softkey) to display white screen. Continue pressing the left softkey to view all remaining screens (black, blue, red, and green) and then exit. End the test early by pressing the right softkey. - <i>System Monitoring</i> Displays RSSI and battery voltage information. • Status Display handset status (Firmware, Model, Hardware, IPEI ...)
Call Settings	<ul style="list-style-type: none"> • Do Not Disturb Enable/disable do not disturb mode on the phone. • Call Waiting Configure call waiting feature. • Call Forward Configure call forward feature. • Speed Dial Assign contact numbers as speed dial. • Outgoing Default Line Select outgoing default line. • Auto Answer Enable/disable auto answer feature. • Lines Display the line status.
Tools	<ul style="list-style-type: none"> • Alarm <ul style="list-style-type: none"> - <i>Set Alarm:</i> Configure the alarm - <i>Alarm Settings:</i> Configure Alarm Settings (Alarm Volume, Alarm Tone, Snooze Time)

CONFIGURATION GUIDE

The DP750 can be configured one of two ways:



- Web GUI embedded on the DP750 using PC's web browser.
- LCD Configuration Menu using the paired DP720 keypad.

Via Web GUI you can configure all the functions supported by the DP750; while via paired DP720, you can access limited configuration and need the base station PIN code for some options.

Obtain DP750 Base Station IP Address via paired DP720

DP750 is by default configured to obtain IP address from DHCP server where the unit is located. In order to know which IP address is assigned to your DP750, please follow below steps using a paired DP720 handset with your DP750 base station.

Please see [Register DP720 Handset to DP750 Base Station](#)

1. Press "Menu" (left softkey)  or **OK** button  on DP720 to view operation menu.
2. Press Arrow (Up, Down, Left, Right) keys to move the cursor to **Setting** icon , then press "Select" (left softkey).
3. Press Up arrow key to navigate to **Status**, then press "Select".



4. The LCD screen will display information about the DP720.
5. Using Arrow keys, navigate down to view the IP address of the DP750.



Configuration via Web Browser

The DP750 embedded Web server responds to HTTP / HTTPS GET/POST requests. Embedded HTML pages allow a user to configure the DP750 through a Web browser such as Google Chrome, Mozilla Firefox and Microsoft's IE.

Accessing the Web UI

1. Connect the computer to the same network as DP750.
2. Make sure the DP750 is booted up.
3. You may check DP750 IP address via a subscribed DP720 on its LCD menu at: **Settings > Status > IP Address**. Please see [Obtain DP750 Base station IP Address via paired DP720](#)
4. Open Web browser on your computer.
5. Enter the DP750's IP address in the address bar of the browser.
6. Enter the administrator's username and password to access the Web Configuration Menu.

Note:

The computer must be connected to the same sub-network as the DP750. This can be easily done by connecting the computer to the same hub or switch as the DP750.

Saving the Configuration Changes

After users makes changes to the configuration, pressing the **Save** button will save but not apply the changes until the **Apply** button on the top of web GUI page is clicked. Users can instead directly press the **Save and Apply** button. We recommend rebooting or powering cycle the phone after applying all the changes.

Web UI Access Level Management

There are two default passwords for the login page:

User Level	Username	Password	Web Pages Allowed
End User Level	user	123	Only Status and Maintenance
Administrator Level	admin	admin	All pages

The password is case sensitive with maximum length of 25 characters.

Note: When accessing the web GUI with normal user level, "Advanced Settings" page will be hidden.

When changing any settings, always SUBMIT them by pressing the **Save** or **Save and Apply** button on the bottom of the page. If using the **Save** button, after making all the changes, click on the **Apply** button on top of the page to submit. After submitting the changes in all the Web GUI pages, reboot DP750 to have the changes take effect if necessary; most of the options under the **Settings** page require reboot, but options under the **Accounts** and **Phonebook** pages do not.



Changing User Level Password

1. Access your DP750 base station web UI by entering its IP address in your favorite browser.
2. Enter your admin password (default: admin).
3. Press **Login** to access your settings.
4. Go to **Maintenance > Web/SSH Access**.
5. In **Web/SSH Access** page, locate **User Password** section:
 - a. Type in your new user password in **New Password** field.
 - b. Type in again same entered password in **Confirm Password** field.
6. Press **Save and Apply** to save your new setting.

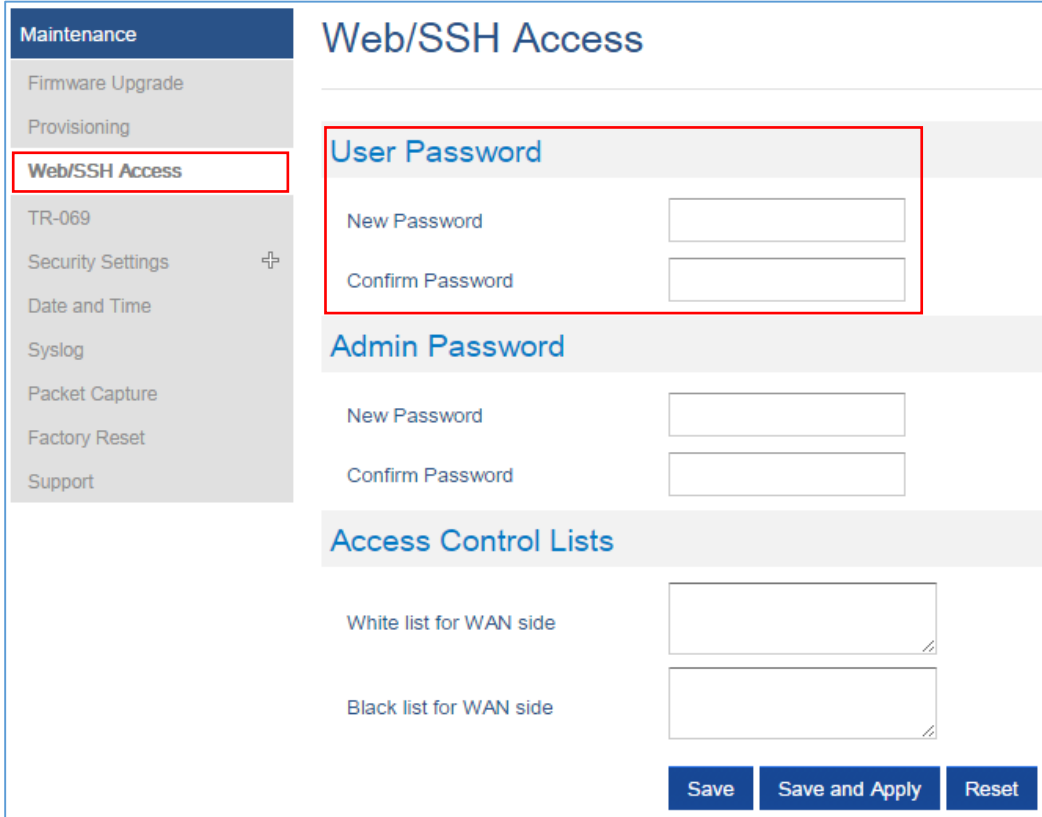

The screenshot shows the 'Web/SSH Access' configuration page. On the left is a navigation menu with 'Web/SSH Access' selected. The main content area has three sections: 'User Password', 'Admin Password', and 'Access Control Lists'. The 'User Password' section is highlighted with a red box and contains two input fields: 'New Password' and 'Confirm Password'. The 'Admin Password' section also has two input fields: 'New Password' and 'Confirm Password'. The 'Access Control Lists' section has two input fields: 'White list for WAN side' and 'Black list for WAN side'. At the bottom right are three buttons: 'Save', 'Save and Apply', and 'Reset'.

Figure 9: User Level Password

Note: DO NOT USE same password for both user and admin accounts.

Changing Admin Level Password

1. Access your DP750 base station web UI by entering its IP address in your favorite browser.
2. Enter your admin password (default: admin).
3. Press **Login** to access your settings.
4. Go to **Maintenance > Web/SSH Access**.
5. In **Web/SSH Access** page, locate **Admin Password** section:

- a. Type in your new Admin Password in **New Password** field.
 - b. Type in again same entered password in **Confirm Password** field.
6. Press **Save and Apply** to save your new setting.

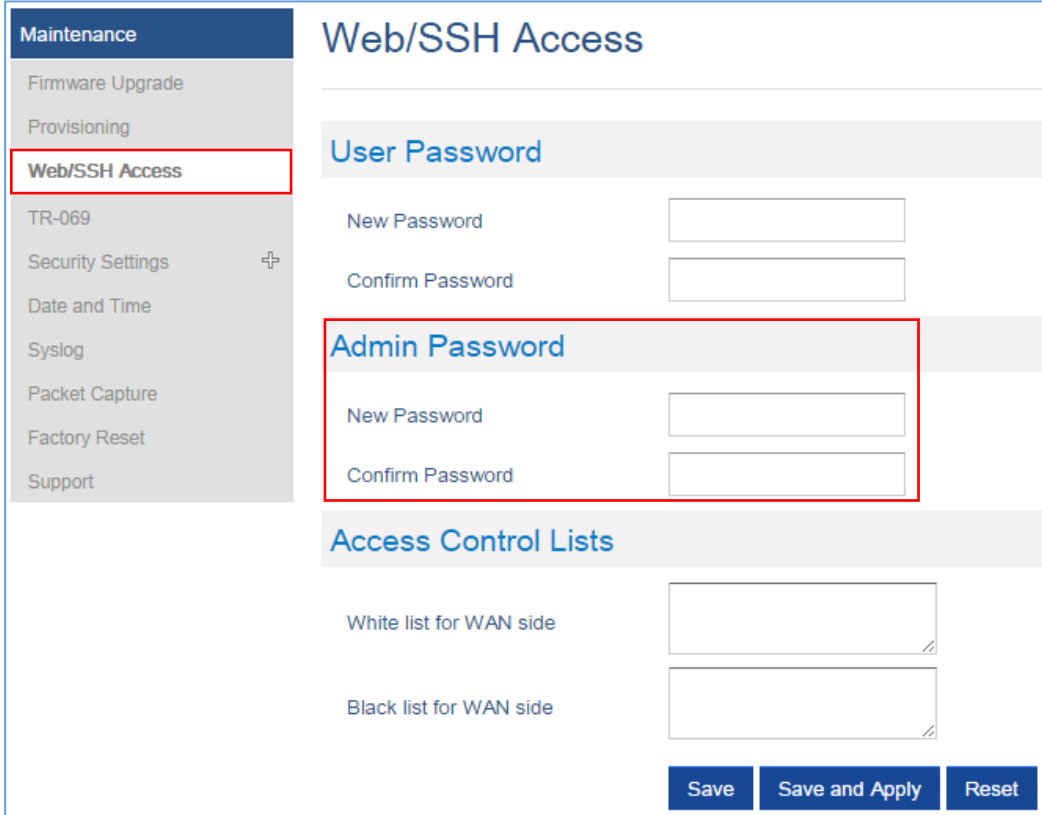

Figure 10: Admin Level Password

Note: DO NOT USE same password for both user and admin accounts.

Changing HTTP / HTTPS Web Access Port

1. Access your DP750 base station web UI by entering its IP address in your favorite browser.
2. Enter your admin password (default: admin).
3. Press **Login** to access your settings.
4. Go to **Maintenance > Security Settings > Web/SSH**.
5. In **Web/SSH Settings** page, locate **HTTP / HTTPS Web Port** field and change it to your desired/new HTTP / HTTPS port.

Note: By default, the HTTP port is 80 and HTTPS is 443.

6. Select the **Web Access Mode** depending on desired protocol (HTTP or HTTPS).
7. Press **Save and Apply** to save your new setting.

Note: A reboot is required for this change to take effect.

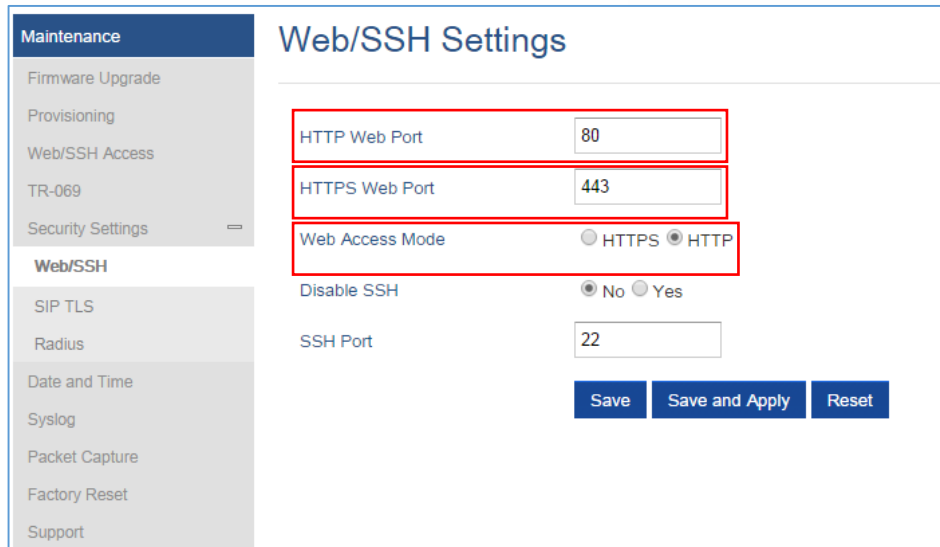

Figure 11: Web Access Port

Web Configuration Definitions







This section describes the options in the DP750 Web UI. As mentioned, you can log in as an administrator or an end user.

- **Status:** Display the system info, network status, DECT status, account status, and line options.
- **Profiles:** Configure the profiles with general settings, network settings, SIP settings, audio settings, call settings and ring tones.
- **DECT:** Configure DECT general settings, account settings and handset line settings.
- **Settings:** Configure ring tones and system features.
- **Maintenance:** Configure networks, upgrading and provisioning, web/SSH access, TR-069, security settings, date and time, and syslog.
- **Phonebook:** Manage phonebooks: global/shared (XML or LDAP) and private (XML).



Status Page Definitions

Table 9: Status Page Definitions



Account Status	
Account	Displays list of configured accounts' names, from Account 1 to Account 10.
SIP User ID	Displays list of SIP user id registered.
SIP Server	Displays list of SIP Server.

SIP Registration	Shows the status of SIP registration. If the SIP account is successfully registered, it will display “YES” with green background. If the SIP account is not registered, it will display “NO” with red background.
HS Mode	Displays the HS mode configured for each account.
HS status table	<p>Illustrates both handsets and SIP accounts statuses. Each column is dedicated to one HS; each row shows the status of the account on that HS:</p> <ul style="list-style-type: none">  Gray: HS is not configured to use this account.  Green: HS is idle on this account.  Green Blinking: HS is using this account.  Red: HS is not available.  Red/Orange Blinking: HS is ringing on this account.  Brown: The line is configured, but the handset is not subscribed. <p>For example, if accounts 1, 3 and 4 are assigned to HS3 with account 3 in use, the column for HS3 will have cell 3 with red icon, cells 1 and 4 with green icon, and cells 2 and 5 with gray icon.</p>

DECT Status

Base Station Name	Displays name of base station. Default is DP750_[last 6 digit of MAC address] .
Base DECT FW Version	Shows firmware version of base DECT.
Base DECT RF Region	Indicates region of base DECT RF.
Base DECT RFPI Address	Specifies DECT RFPI (Radio Fixed Part Identity) address which is a unique identity for the base.
Global Functions	<ul style="list-style-type: none"> - Page Handsets: Sends a paging request to all subscribed handsets; they will receive incoming ring tone and “Paging” will be displayed on their LCD screens. - Open Subscription: Opens subscription to allow a handset to be subscribed. - Unsubscribe Handsets: Unsubscribes all handsets from DECT base station.
Handset Status	<ul style="list-style-type: none"> • Handset Name: Displays index and name (customizable) of each handset. • IPEI: Indicates IPEI number of each handset; this is the unique identity for the handset. If the handset is in range, the IPEI will be displayed with a green background, otherwise, it will be displayed with a red background. • Battery icon  : Illustrates battery status for each Handset; it can be either: <ul style="list-style-type: none">  Fully charged



	<ul style="list-style-type: none">  Not fully charged  Low, needs to be charged or replaced  Charging <ul style="list-style-type: none"> Page: Sends paging request to corresponding handset, which will get an incoming ring; this function helps you locate the handsets. Unsubscribe: Unsubscribes corresponding handset from DECT base station. HS Firmware: Indicates handset's firmware version number. Upgrade: Shows handset upgrade status or trigger handset upgrade process.
--	--

Line Options

Account	Displays list of configured accounts' names, from Account 1 to Account 10.
SIP User ID	Displays list of SIP user id registered.
DND	Shows DND (Do Not Disturb) feature status (per SIP account).
Forward	Indicates destination to which all incoming calls will be forwarded (per SIP account).
Busy Forward	Indicates destination to which incoming calls will be forwarded when the line is busy (per SIP account).
Delayed Forward	Indicates destination to which incoming calls will be forwarded if the call is not answered within a specified period of time or number of rings (per SIP account).

Network Status

MAC Address	Shows Device ID in hexadecimal format. This is needed by network administrators for troubleshooting. The MAC address will be used for provisioning and can be found on the label on original box and on the label located on the bottom panel of the device.
IP Address Mode	Indicates used IP address mode: DHCP, Static IP or PPPoE.
IP Address	Displays assigned IP address. Example: 192.168.5.110
Subnet Mask	Displays assigned subnet mask. Example: 255.255.255.0
Gateway	Displays assigned default gateway. Example: 192.168.5.1
PPPoE Link Up	Indicates PPPoE connection status.
DNS Server 1	Shows assigned DNS server address 1. Example: 8.8.8.8
DNS Server 2	Shows assigned DNS server address 2. Example: 8.8.4.4
NAT Traversal	Indicates type of NAT for each Profile. (Based on STUN protocol.)



System Info	
Product Model	Displays product model info. Default is DP750 .
Part Number	Shows product part number. Example: 9610003814A (last 2 digits show HW version, in this example 14A for HW version 1.4A)
Software Version	<ul style="list-style-type: none"> • Firmware Status: Displays the status of the firmware loaded. • Boot: Specifies Boot version. Current is 1.0.2.16 • Core: Specifies Core version. Current is 1.0.2.16 • Base: Specifies Base version. Current is 1.0.2.16 • Prog: Specifies Prog version. Current is 1.0.2.16. This is the main firmware release number, which is always used for identifying the software system of the DP750. • Locale: Specifies Locale version. Current is 1.0.2.16 • Recovery: Specifies Recovery version. Current is 1.0.2.16 • Handset: Specifies Handset firmware version. Current is 1.0.2.16
System Up Time	Indicates system uptime since last reboot.
System Time	Shows actual time and date according to your configuration.
Service Status	Reveals status of VoIP applications.
Core Dump	Provides generated core dump file if unit malfunctions. Normal will be displayed if no issues.

Profiles Page Definitions

Table 10: Profiles Page Definitions

General Settings	
Profile Active	Activates or deactivates SIP profile.
SIP Server	Configures SIP server IP address or domain name provided by VoIP service provider. This is the primary SIP server used to send/receive SIP messages from/to DP750.
Failover SIP Server	Specifies failover SIP server IP address or domain name provided by VoIP service provider. This server will be used if the primary SIP server becomes unavailable.
Prefer Primary SIP Server	Prefers primary SIP server. The profile will register to primary Server if registration with Failover server expires. Default is No .
Outbound Proxy	Specifies IP address or domain name of outbound proxy, media gateway or session border controller. Used by DP750 for firewall or NAT penetration in



	different network environments. If symmetric NAT is detected, STUN will not work and only outbound proxy can correct the problem.
Voice Mail Access Number	Defines the voice mail portal access number to allow users accessing their voice messages.
Network Settings	
Layer 3 QoS Settings	Defines Diff-Serv values for SIP and RTP. Defaults are: SIP Diff-Serv: 24 RTP Diff-Serv: 46
DNS Mode	Selects DNS mode to use for the client to look up server. One mode can be chosen. <ul style="list-style-type: none"> • A Record: resolves IP Address of target according to domain name. • SRV: DNS SRV resource records indicate how to find services for various protocols. • NAPTR/SRV: Naming Authority Pointer according to RFC 2915. • Use Configured IP: If selected, please fill in Primary IP, Backup IP 1 and Backup IP 2 to be used for server look up. Default is A Record .
Primary IP	Specifies primary IP address where the base sends DNS query to, when “Use Configured IP” is selected for DNS mode.
Backup IP 1	Specifies backup IP 1 address where the base sends DNS query to, when “Primary IP” is not responding.
Backup IP 2	Specifies backup IP 2 address where the base sends DNS query to, when “Backup IP 1” is not responding.
NAT Traversal	Enables/disables NAT traversal mechanism. If activated (by choosing “STUN”) and a STUN server is also specified (Maintenance > Network Settings > STUN Settings); the base performs according to STUN client specification. Under this mode, embedded STUN client will detect if and what type of firewall/NAT is being used. If detected NAT is a Full Cone, Restricted Cone, or a Port-Restricted Cone, the base will use its mapped public IP address and port in all of its SIP and SDP messages. If NAT Traversal field is set to “Keep Alive”, the base will periodically (every 20 seconds) send a blank UDP packet (with no payload data) to SIP proxy to keep the “ping hole” on the NAT open.
Use NAT IP	Defines NAT IP address used in SIP/SDP messages. It should only be used if required by ITSP.



Proxy-Require	Determines a SIP Extension to notify the SIP server that the base is behind a NAT/Firewall.
SIP Settings – Basic Settings	
SIP transport	Selects transport protocol for SIP packets; UDP or TCP or TLS. Make sure your SIP server or network environment supports SIP over the selected transport method. Default is UDP .
SIP Registration	Controls whether to send SIP REGISTER messages to the proxy server. Device may not be able to make/receives calls if disabled. Default is Yes .
Unregister on Reboot	Controls whether to clear SIP user's information by sending un-register request to the proxy server. The un-registration is performed by sending a REGISTER message with "Contact" header set to * and Expires=0 parameters to the SIP server. This will unregister all SIP accounts under concerned Profile. Default is No .
Add Auth Header on Initial REGISTER	Adds "Authentication" header with blank "nonce" attribute in the initial SIP REGISTER request. Default is No .
Outgoing Calls Without Registration	<p>Enables the ability to place outgoing calls even when not registered (if allowed by ITSP); device will not be able to receive incoming calls. Any HS member of a hunting group that is not registered with a SIP account, will be able to place outbound calls using the SIP credentials of the primary hunting group HS. Default is No.</p> <p><u>For example:</u> HS 1, 3 and 5 are members of the same Hunting Group. HS 1 is registered with a SIP account. HS 3 and 5 are not registered. HS 3 and 5 will be able to place outbound calls using the SIP account of HS 1, even if Outgoing Call without Registration is set to No.</p>
Register Expiration	Refreshes registration periodically with specified SIP proxy (in minutes). Maximum interval is 65535 minutes (about 45 days). Default is 60 minutes (or 1 hour).
SIP Registration Failure Retry Wait Time	Sends re-register request after specific time (in seconds) when registration process fails. Maximum interval is 3600 seconds (1 hour). Default is 20 seconds.
SIP Registration Failure Retry Wait Time upon 403 Forbidden	Sends re-register request after specific time (in seconds) when registration process fails due to "403 Forbidden". Valid range is 0 to 3600 in second. 0 second means stop retry registration. Default is 1200 seconds.
Reregister Before Expiration	Sends re-register request after specific time (in seconds) to renew registration before the previous registration session expires.



Local SIP Port	Defines local port to use by the base for listening and transmitting SIP packets. Default value for Profile 1 is 5060, 6060 for Profile 2, 7060 for Profile 3 and 8060 for Profile 4.
Use Random SIP Port	Controls whether to use configured or random SIP ports. This is usually necessary when multiple base stations are behind the same NAT. Default is No .
SIP T1 Timeout	Defines T1 timeout value. It is an estimate of the round-trip time between the client and server transactions. For example, the base station will attempt to send a request to a SIP server. The time it takes between sending out the request to the point of getting a response is the SIP T1 timer. If no response is received the timeout is increased to (2*T1) and then (4*T1). Request re-transmit retries would continue until a maximum amount of time defined by T2. Default is 0.5 seconds.
SIP T2 Timeout	Identifies maximum retransmission interval for non-INVITE requests and INVITE responses. Retransmitting and doubling of T1 continues until it reaches T2 value. Default is 4 seconds.
SIP Timer D	Configures SIP timer D defined in RFC3261. Range of values 0-64. Default is 0 .
Remove OBP from Route Header	Removes outbound proxy information from "Route" header when sending SIP packets. Default is No .
Support SIP Instance ID	Adds "SIP Instance ID" attribute to "Contact" header in REGISTER request as defined in IETF SIP outbound draft. Default is No .
Hold Target Before Refer	Sends re-INVITE to hold transfer target before sending REFER message to transferee. Default is Yes .
Refer-To Use Target Contact	Includes target's "Contact" header information in "Refer-To" header when using attended transfer. Default is No .
SUBSCRIBE for MWI	Sends periodic "SUBSCRIBE" requests (depends on "Register Expiration" parameter) for message waiting indication service. Default is No .
Enable 100rel	Appends "100rel" attribute to the "required" header of the initial signaling messages. Default is No .
TEL URI	<p>Indicates E.164 number in "From" header by adding "User=Phone" parameter or using "Tel:" in SIP packets, if the base has an assigned PSTN Number.</p> <ul style="list-style-type: none"> • Disabled: Will use "SIP User ID" information in the Request-Line and "From" header. • User=Phone: "User=Phone" parameter will be attached to the Request-Line and "From" header in the SIP request to indicate the E.164 number. If set to "Enable".



	<ul style="list-style-type: none"> • Enabled: "Tel:" will be used instead of "sip:" in the SIP request. Please consult your carrier before changing this parameter. Default is Disabled .
Do Not Escape '#' as %23 in SIP URI	Replaces “#” by “%23” when sending SIP packets. Default is No .
Disable Multiple m Line in SDP	Sends only one m line in SDP, regardless of how many m fields are in the incoming SDP. Default is No .
Use Privacy Header	Adds “Privacy” header if special feature is set to “Default”, and not “CBCOM”.
Use P-Preferred-Identity Header	Adds “PPI” header if special feature is set to “Default”, and not “CBCOM”.
SIP Settings - Session Timer	
Session Expiration	Enables periodic refresh of SIP session via a SIP request (UPDATE, or re-INVITE). When the session interval expires and there is no refresh via an UPDATE or re-INVITE message, the session will be terminated. Session Expiration is the time (in seconds) at which the session is considered timed out, if no successful session refresh transaction occurs beforehand. Default is 180 seconds.
Min-SE	Defines Minimum session expiration (in seconds). Default is 90 seconds.
Caller Request Timer	Uses session timer when making outbound calls if remote party supports it. Default is No .
Callee Request Timer	Uses session timer when receiving inbound calls with session timer request. Default is No .
Force Timer	Uses session timer even if the remote party does not support this feature. Selecting “No” will enable session timer only when the remote party supports it. Default is No . To turn off Session Timer, select “No” for Caller Request Timer, Callee Request Timer, and Force Timer.
UAC Specify Refresher	Specifies which end will act as refresher for outgoing calls: <ul style="list-style-type: none"> • UAC: The base station acts as the refresher. • UAS: Callee or proxy server act as the refresher. Default is Omit .
UAS Specify Refresher	Specifies which end will act as refresher for incoming calls: <ul style="list-style-type: none"> • UAS: The base station acts as the refresher.



	<ul style="list-style-type: none"> • UAC: Callee or proxy server act as the refresher. Default is Omit.
Force INVITE	Uses INVITE message to refresh the session timer. Default is No .
SIP Settings - Security Settings	
Validate Incoming Messages	Defines whether incoming messages will be validated or not. Default is No .
Check SIP User ID for Incoming INVITE	Checks SIP User ID in the Request URI of incoming INVITE; if it doesn't match the base SIP User ID, the call will be rejected. Direct IP calling will also be disabled. Default is No .
Accept Incoming SIP from Proxy Only	Checks SIP address of the Request URI in the incoming SIP message; if it doesn't match SIP server address of the account, the call will be rejected. Default is No .
Authenticate Incoming INVITE	Challenges the incoming INVITE for authentication with SIP 401 Unauthorized message. Default is No .
Authenticate Server Certificate Domain	Checks server TLS certificate to ensure that common name matches the configured SIP server. Default is No .
Authenticate Server Certificate Chain	Checks server TLS certificate to ensure that it is authorized by a known certificate authority. Default is No .
Trusted CA Certificate	Treats entered certificate as a valid CA for authenticating the server TLS certificate. Default is No .
Audio Settings	
Preferred DTMF method (in order)	Sorts DTMF methods (in-audio, via RTP (RFC2833) or via SIP INFO) by priority.
Disable DTMF Negotiation	Uses above DTMF order without negotiation. Default is No .
DTMF Payload Type	Defines payload type for DTMF using RFC2833.
Preferred Vocoder	Configures vocoders in a preference list (up to 8 preferred vocoders) that will be included with same order in SDP message. Vocoder types are G.711 A-/U-law, G.722, G.726-32, G.723, G.729, iLBC and OPUS
Voice Frames per TX	Transmits a specific number of voice frames per packet. Default is 2 ; increases to 10/20/32/64 for G711/G726/G723/other codecs respectively.
G723 Rate	Operates at specified encoding rate for G.723 vocoder. Available encoding rates are 6.3kbps or 5.3kbps. Default is 6.3kbps .



G726-32 Packing Mode	Defines G726-32 packing mode (“ITU” or “IETF”). Default is ITU .
iLBC Frame Size	Specifies iLBC packet frame size (20ms or 30ms). Default is 20ms .
iLBC Payload type	Determines payload type for iLBC. The valid range is between 96 and 127. Default is 97 .
Disable OPUS stereo in SDP	Disables OPUS stereo attribute in SDP header. Default is No .
OPUS Payload Type	Determines OPUS payload type. The valid range is between 96 and 127. Default is 125 .
Use First Matching Vocoder in 200OK SDP	Includes only the first matching vocoder in its 200OK response, otherwise it will include all matching vocoders in same order received in INVITE. Default is No .
SRTP Mode	Selects SRTP mode to use (“Disabled”, “Enabled but not forced”, or “Enabled and forced”). Default is Disabled It uses SDP security description to exchange key. Please refer to SDES: https://tools.ietf.org/html/rfc4568 SRTP: https://tools.ietf.org/html/rfc3711
Crypto Life Time	Adds crypto life time header to SRTP packets. Default is Yes .
Silence Suppression (VAD)	Allows detecting the absence of audio and conserves bandwidth by preventing the transmission of "silent packets" over the network. Default is No .
Jitter Buffer Type	Selects jitter buffer type (Fixed or Adaptive) based on network conditions.
Jitter Buffer Length	<ul style="list-style-type: none"> • High (initial 200ms, min 40ms, max 600ms) Note: not all vocoders can meet the high requirement. • Medium (initial 100ms, min 20ms, max 200ms). • Low (initial 50ms, min 10ms, max 100ms).
Call Settings	
Early Dial	Sends an early INVITE each time a key is pressed when a user dials a number. Otherwise, only one INVITE is sent after full number is dialed (user presses Dial Key or after “no key entry timeout” expires). This option should be used only if there is a SIP proxy configured and supporting “484 Incomplete Address” responses. Otherwise, the call will likely be rejected by the proxy (with a 404 Not Found error). Default is No . <i><u>This feature is NOT designed to work with and should NOT be enabled for direct IP-to-IP calling.</u></i>



Dial Plan Prefix	Adds specified prefix to dialed number.
Dial Plan	<p>Dial Plan Rules:</p> <ol style="list-style-type: none"> 1. Accept Digits: +,1,2,3,4,5,6,7,8,9,0 , * , #, A,a,B,b,C,c,D,d 2. Grammar: x - any digit from 0-9; <ol style="list-style-type: none"> a. xx+ - at least 2 digits number; b. xx – exactly 2 digits number; c. ^ - exclude; d. . – wildcard, matches one or more characters e. [3-5] - any digit of 3, 4, or 5; f. [147] - any digit 1, 4, or 7; g. <2=011> - replace digit 2 with 011 when dialing h. <=1> - add a leading 1 to all numbers dialed, vice versa will remove a 1 from the number dialed i. - or <ul style="list-style-type: none"> • Example 1: {[369]11 1617xxxxxxx} – Allow 311, 611, 911, and any 10 digit numbers of leading digits 1617 • Example 2: {^1900x+ <=1617>xxxxxxx} – Block any number with leading digits 1900 and add prefix 1617 for any dialed 7 digit numbers • Example 3: {1xxx[2-9]xxxxxx <2=011>x+} – Allow any length of number with leading digit 2 and 10 digit-numbers of leading digit 1 and leading exchange number between 2 and 9; If leading digit is 2, replace leading digit 2 with 011 before dialing. 3. Default: Outgoing - {x+} <p><u>Example of a simple dial plan used in a Home/Office in the US:</u> { ^1900x. <=1617>[2-9]xxxxxx 1[2-9]xx[2-9]xxxxxx 011[2-9]x. [3469]11 }</p> <p>Explanation of example rule (reading from left to right):</p> <ul style="list-style-type: none"> • ^1900x. - prevents dialing any number started with 1900 • <=1617>[2-9]xxxxxx - allows dialing to local area code (617) numbers by dialing 7 numbers and 1617 area code will be added automatically • 1[2-9]xx[2-9]xxxxxx - allows dialing to any US/Canada Number with 11 digits length • 011[2-9]x. - allows international calls starting with 011 • [3469]11 - allow dialing special and emergency numbers 311, 411, 611 and 911



	<ul style="list-style-type: none"> • \+x+ - allow dialing any digit with leading + sign; example: +16175669300 <p>Note: In some cases, user wishes to dial strings such as *123 to activate voice mail or other application provided by service provider. In this case * should be predefined inside dial plan feature. An example dial plan will be: { *x+ } which allows the user to dial * followed by any length of numbers.</p>
Use # as Dial Key	Treats “#” as the “Send” (or “Dial”) key. If set to “No”, this “#” key can be included as part of the dialed number. Default is Yes .
No Key Entry Timeout	Initiates the call within this time interval if no additional key entry during dialing stage. Default is 4 seconds.
Off-Hook Auto-Dial Delay	Waits for specified time (in seconds) after off-hook before autodialing the preconfigured number. The range is 0 to 60 seconds.
Enable Call Features	Enables do not disturb, call forward and other call features via the local feature codes on the base. Otherwise, ITSP feature codes can be used. Default is Yes .
Disable Call Waiting Caller ID	Disables displaying caller ID when receiving a second incoming call. Default is No .
Disable Call Waiting Tone	Disables playing call waiting tone during active call when receiving a second incoming call. The CWCID will still be displayed. Default is No .
Disable Visual MWI	Disables use of visual message waiting indicator when there is an unread voicemail message. Default is No .
Transfer on Conference Hang-up	Transfers the call to the other party if the conference initiator hangs up. Default is No .
Ring Timeout	Stops ringing when incoming call is not answered within a specific period of time. Default is 60 seconds.
Hunting Group Ring Timeout	Forwards incoming call to the next member of a hunt group if not answered within a specific period of time. Default is 20 seconds.
Send Anonymous	Sets “From”, “Privacy” and “P_Asserted_Identity” headers in outgoing INVITE message to “anonymous”, blocking caller ID. Default is No .
Anonymous Call Rejection	Rejects incoming calls with anonymous caller ID with “486 Busy here” message. Default is No .
Special Feature	Selects Soft switch vendors’ special mode. Example of vendors: Broadsoft, CBCOM, RNK, Huawei, ZTE IME, PhonePower, Metaswitch. Default is Standard .



DECT Page Definitions

Table 11: DECT Page Definitions

General Settings		
Base Station Name	Displays the name of the base station. Default is DP750_[last 6 digit of MAC address] .	
Admin PIN Code	Configures admin PIN code for authentication. Default is 0000 .	
Enable Repeater Mode	Enables / disables the base station repeater mode. Default is No .	
Clear Call Logs	Deletes call history logs of all handsets from base station.	
Handset Settings	Handset	Displays list of handsets' indexes, from HS 1 to HS 5.
	Handset Name	Allows to customize handset name. Default is "HS1" to "HS5"
	Handset Phonebook	Assigns private phonebook to handset. Each handset has a private phonebook or can be disabled. A private phonebook can be shared between specific handsets. <u>Example:</u> PB1 assigned to HS1 and HS2
	Off-hook Auto-dial	Configure a number to auto dial when off-hook.
SIP Account Settings		
Account	Displays list of accounts' indexes, from account 1 to account 10.	
SIP User ID	Enters SIP user ID provided by VoIP service provider (ITSP). Usually in the form of digit similar to phone number or actually a phone number.	
Authenticate ID	Enters account authenticate ID provided by VoIP service provider (ITSP). Can be identical to or different from "SIP user ID".	
Password	Specifies account password provided by VoIP provider (ITSP) to register to SIP servers.	
Name	Chooses a name to be associated to user.	
Profile	Selects the profile ID (1/2/3/4).	
HS Mode	Determines HS modes; the base station supports 4 hunting group modes and 1 non-hunting group:	



	<ul style="list-style-type: none"> • Circular mode: all phones ring sequentially, starting with the phone after the one which rang last. • Linear mode: all phones ring sequentially in the predetermined order, starting with the first phone each time. • Parallel mode: all phones ring concurrently; after one phone answers, the remaining available phones can make new calls • Shared mode: all phones ring concurrently and always share the same line (similar to analog phones). • Non-Hunting Group: an account will be assigned to a single specific handset.
Active	Activates/deactivates the account.
Handset Line Settings	
Handset Line Settings	Configures handset line settings; the base station supports up to 10 SIP accounts, 5 handsets; each Handset can be configured with up to 10 accounts. Please be aware that the handset line settings will be affected by DID settings (hunting group settings) in “DECT - SIP Account Settings”.

Settings Page Definitions

Table 12: Settings Page Definitions

Network Settings – Basic Settings		
IP Address Mode	Selects IP address mode (DHCP, Static IP or PPPoE) for DP750 Base Station.	
Preferred DNS Server	Specifies preferred DNS server to use when DHCP, PPPoE or Static mode is set.	
DHCP Settings	Host name (Option 12)	Specifies the name of the client. The name may or may not be qualified with the local domain name. This field is optional but may be required by ISP.
	DHCP Domain	Specifies the domain name that client should use when resolving hostnames via domain name system. This value is optional, but may be required by ISP.
	Vendor Class ID (Option 60)	Exchanges vendor class ID by clients and servers to convey particular configuration or other identification information about a client. Default is DP7XX .
PPPoE Settings	Configures PPPoE account ID, password and service name.	



Static IP Settings	Sets IP address, subnet mask, gateway, DNS server 1, and DNS server 2.	
Network Settings – Advanced Settings		
802.1X Mode	Enables/Disables 802.1X mode. To enable this mode, you should select EAP-MD5. Default is Disable .	
802.1X Identity	Configures the identity for 802.1X mode.	
MD5 Password	Determines the MD5 password for 802.1X mode.	
802.1X CA Certificate	Uploads / deletes the 802.1X CA certificates.	
802.1X Client Certificate	Uploads / Deletes the 802.1X Client Certificates.	
Enable LLDP	Activates LLDP (Link Layer Discovery Protocol). Default is No .	
Layer 2 QoS Settings	Enable VLAN	Enables / Disables the VLAN mode. Default is Disabled .
	Layer 2 QoS 802.1Q/VLAN Tag	Sets layer 2 QoS 802.1Q/VLAN tag. Default is 0.
	Layer 2 QoS 802.1p Priority Value for SIP signaling	Sets layer 2 QoS 802.1p priority value for SIP signaling. Default is 0 .
	Layer 2 QoS 802.1p Priority Value for RTP media	Sets layer 2 QoS 802.1p priority value for RTP media. Default is 0 .
STUN Settings	Use STUN	Enables STUN. Default is No .
	STUN server	Configures IP address or domain name of STUN server. Only non-symmetric NAT routers work with STUN.
	Number of STUN Response Misses Allowed	Specifies number of STUN response misses allowed before restarting DHCP service. The minimum is 3 misses.



	Keep-Alive Interval	Sends periodically a blank UDP packet to SIP server in order to keep the "ping hole" on the NAT router open. Default is 20 seconds.
Ring Tones		
	System Ring Cadence	Sets ring cadences for all incoming calls. Syntax: c=on1/off1-on2/off2-on3/off3;) Default is set to c=2000/4000; (US standards) on1 is the period of ringing ("On time" in "ms") while off1 is the period of silence. Up to three cadences are supported.
	Call Progress Tones	Configures tone frequencies according to user preference. By default, the tones are set to North American frequencies. Frequencies should be configured with known values to avoid uncomfortable high pitch sounds. ON is the period of ringing ("On time" in "ms") while OFF is the period of silence. In order to set a continuous ring, OFF should be zero. Otherwise it will ring ON ms and a pause of OFF ms and then repeats the pattern. <ul style="list-style-type: none"> • "Dial tone" • "Ring back tone" • "Busy tone" • "Reorder tone" • "Confirmation tone" • "Call-Waiting tone" <p>Please refer to the document below to determine your local call progress tones: http://www.itu.int/ITU-T/inr/forms/files/tones-0203.pdf</p>
System Features		
	Disable Direct IP Call	Deactivates Direct IP-to-IP calling function. Default is No .

Maintenance Page Definitions

Table 13: Maintenance Page Definitions

Firmware Upgrade	
Firmware Upgrade and Provisioning	Selects how firmware upgrade request will be sent: "Always Check for New Firmware", "Check New Firmware only when F/W pre/suffix changes", or "Always Skip the Firmware Check".
HTTP/HTTPS User Name	Enters user name to authenticate with HTTP/HTTPS server.



HTTP/HTTPS Password	Enters password to authenticate with HTTP/HTTPS server.	
Always send HTTP Basic Authentication Information	Includes configured user name and password in HTTP request before receiving authentication challenge from the server. Default is No .	
Verify host when using HTTPS	Verifies host name in server certificate when using HTTPS. Default is Yes .	
Upgrade via	Selects firmware upgrade method: TFTP, HTTP or HTTPS.	
Firmware Server Path	Sets IP address or domain name of firmware server. The URL of the server that hosts the firmware release. Default is fm.grandstream.com/gs . Note: Make sure to not prepend address with "http://" or any other protocol.	
Firmware File Prefix	Checks if firmware file is with matching prefix before downloading it. This field enables user to store different versions of firmware files in one directory on the firmware server.	
Firmware File Postfix	Checks if firmware file is with matching postfix before downloading it. This field enables user to store different versions of firmware files in one directory on the firmware server.	
Allow DHCP Option 43 and Option 66 to Override Server	Obtains configuration and upgrade server's information from DHCP server using options 66 and 43. Note: If DHCP Option 66 is enabled, the base will attempt downloading the firmware file from the server URL provided by DHCP, even though Firmware Server Path is left blank.	
Automatic Upgrade	Specifies when the firmware upgrade process will be initiated; there are 4 options: <ul style="list-style-type: none"> • No: Base station will only do upgrade once at boot up. • Check every X minutes: User needs to specify a period in minutes. • Check every day: User needs to specify "Hour of the day (0-23)". • Check every week: User needs to specify "Hour of the day (0-23)" and "Day of the week (0-6)". <u>Note:</u> Day of week is starting from Sunday. Default is No. 	
Firmware Key	Decrypts the firmware file using specified key (32-digit in Hexadecimal) when encrypted.	
Handset Firmware	Upload	Uploads handset firmware. Reboot the device after uploading to apply and use the new firmware.
	Delete	Deletes previously uploaded handset firmware.



	Automatic Upgrade	Enables automatic upgrade when the handset detects the new firmware.
Provisioning		
Lock Keypad Update		Restricts base station configuration from paired handsets. Default is No .
XML Config File Password		Decrypts XML configuration file when encrypted. The password used for encrypting the XML configuration file is using OpenSSL.
HTTP/HTTPS User Name		Enters user name to authenticate with HTTP/HTTPS server.
HTTP/HTTPS Password		Enters password to authenticate with HTTP/HTTPS server.
Always send HTTP Basic Authentication Information		Includes configured user name and password in HTTP request before receiving authentication challenge from the server. Default is No .
Verify host when using HTTPS		Verifies host name in server certificate when using HTTPS. Default is Yes .
Provisioning via		Selects provisioning method: TFTP, HTTP or HTTPS
Config Server Path		Sets IP address or domain name of configuration server. The server hosts a copy of the configuration file to be installed on the DP750. Default is fm.grandstream.com/gs . Note: Make sure to not prepend address with "http://" or any other protocol.
Config File Prefix		Checks if configuration files are with matching prefix before downloading them. This field enables user to store different configuration files in one directory on the provisioning server.
Config File Postfix		Checks if configuration files are with matching postfix before downloading them. This field enables user to store different configuration files in one directory on the provisioning server.
Allow DHCP Option 43 and Option 66 to Override Server		Obtains configuration and upgrade server's information from DHCP server using options 66 and 43. Note: If DHCP Option 66 is enabled, the DP750 will attempt downloading the firmware file from the server URL provided by DHCP, even though Config Server Path is left blank.



Allow DHCP Option 120 to Override SIP Server	Obtains configuration and update SIP server information from DHCP server using options 120. Note: If DHCP option 120 is enabled, the sip server setting can be changed for profile 1.	
3CX Auto Provision	Sends multicast “SUBSCRIBE” message for provisioning at booting stage, used for PnP (Plug-and-Play) configuration. Default is Yes .	
Automatic Provisioning	Specifies when provisioning process will be initiated; there are 4 options: <ul style="list-style-type: none"> • No: Base station will only request configuration files once at boot up. • Check every X minutes: User needs to specify a period in minutes. • Check every day: User needs to specify “Hour of the day (0-23)”. • Check every week: User needs to specify “Hour of the day (0-23)” and “Day of the week (0-6)”. Note: Day of week is starting from Sunday. Default is No .	
Authenticate Conf File	Authenticates configuration file before being accepted. This protects the device configuration from unauthorized modifications. Default is No .	
Upload Device Config	Uploads manually device configuration to base station. (Only XML format is supported)	
Device Config (TEXT)	Downloads actual device configuration file in .txt format.	
Device Config (XML)	Downloads default device configuration file in .xml format.	
Web/SSH Access		
User Password	Configures user level password. Case sensitive and max. length of 30 characters.	
Admin Password	Configures admin level password. Case sensitive and max. length is 30 characters.	
Access Control Lists	White list for WAN side	If white list exists, then only these IP addresses are allowed to web and SSH access.
	Black list for WAN side	If black list exists and white list is empty, then only these IP addresses are not allowed to web and SSH access
TR-069		
Enable TR-069	Enables / Disables TR-069 service. Default is No .	
ACS URL	Specifies URL of TR-069 Auto Configuration Server. (e.g., http://acs.mycompany.com), or IP address.	



ACS Username	Enters username to authenticate to ACS.
ACS Password	Enters password to authenticate to ACS.
Periodic Inform Enable	Sends periodic inform packets to ACS. Default is No
Periodic Inform Interval	Configures to sends periodic “Inform” packets to ACS based on specified interval.
Connection Request Username	Enters username for ACS to connect to the base station.
Connection Request Password	Enters password for ACS to connect to the base station.

Security Settings – Web / SSH

HTTP Web Port	Customizes HTTP port used to access base station web UI. Default is 80 .
HTTPS Web Port	Customizes HTTPS port used to access base station web UI. Default is 443 .
Web Access Mode	Determines the protocol to be user for the web interface access. Default is HTTP .
Disable SSH	Disables SSH access. Default is No .
SSH Port	Customizes SSH access port. Default is 22 .

Security Settings – SIP TLS Settings

SIP TLS Certificate	Specifies SSL certificate used for SIP over TLS in X.509 format. Base station has built-in private key and SSL certificate.
SIP TLS Private Key Password	Specifies SSL certificate key used for SIP over TLS in X.509 format. Base station has built-in private key and SSL certificate.
SIP TLS Private Key Password	Specifies SSL certificate key password used for SIP over TLS in X.509 format.

Security Settings – Radius

Primary RADIUS Server	Defines the primary RADIUS server (Remote Authentication Dial-In User Service) to authenticate dial-in users and authorize their access to requested system or service.
Primary RADIUS Authentication Port	Uses specified port for authentication with the primary RADIUS server. Default is 1812 .



Primary RADIUS Account Port	Specifies port to be used for the primary RADIUS account. Default is 1813 .
Primary RADIUS Server Secret	Enters secret string to be used to authenticate the RADIUS connection to the primary server. It should match RADIUS configuration.
Secondary RADIUS Server	Sets IP or FQDN of the secondary RADIUS server. In case primary radius server becomes unusable, secondary will take role of primary and will manage credit resources in the network.
Secondary RADIUS Authentication Port	Uses specified port for authentication with the secondary RADIUS authentication. Default is 1812 .
Secondary RADIUS Account Port	Specifies port to be used for the secondary RADIUS account. Default is 1813 .
Secondary RADIUS Sever Secret	Enters secret string to be used to authenticate the RADIUS connection to the secondary server. It should match RADIUS configuration.
RADIUS Timeout	Specifies period of time before request is cancelled if no response. Default is 2 .
RADIUS Retry	Specifies amount of retry attempts if RADIUS communication failure. Default is 3 .
Date and Time	
NTP Server	Defines URL or IP address of the NTP (Network Time Protocol) server. Used by the base to synchronize the date and time. A list of public NTP servers can be found at http://www.ntp.org .
NTP Update Interval	Contacts NTP server at specified period of time (in minutes) to obtain the date and time. Default is 60 minutes.
Allow DHCP Option 42 to NTP Server	Obtains NTP server address from a DHCP server using DHCP Option 42; it will override configured NTP Server. If set to “No”, the base will use configured NTP server to synchronize time and date even if a NTP server is provided by DHCP server. Default is Yes .
Time Zone	Selects time zone to define date/time on the base.
Self-Defined Time Zone	Allows users to define their own time zone.



Allow DHCP Option 2 to override time zone	Obtains time zone setting (offset) from a DHCP server using DHCP Option 2; it will override selected time zone. If set to “No”, the base station will use selected time zone even if provided by DHCP server. Default is Yes .
Syslog	
Syslog Server	Sets IP address or URL of system log server. The server collects system log information from the base station.
Syslog Level	<p>Selects log level; the level is one of DEBUG, INFO, WARNING, ERROR (default is NONE). Syslog messages are sent based on the following events:</p> <ol style="list-style-type: none"> 1. product model/version on boot up (INFO level) 2. NAT related info (INFO level) 3. sent or received SIP message (DEBUG level) 4. SIP message summary (INFO level) 5. inbound and outbound calls (INFO level) 6. registration status change (INFO level) 7. negotiated codec (INFO level) 8. Ethernet link up (INFO level) 9. SLIC chip exception (WARNING and ERROR levels) 10. memory exception (ERROR level) <p>The Syslog uses USER facility. In addition to standard Syslog payload, it contains the following components: GS_LOG: [device MAC address][error code] error message</p> <p><i>Example:</i> May 19 02:40:38 192.168.1.14 GS_LOG:[00:0b:82:00:a1:be][000] Ethernet link is up</p>
Print SIP in Syslog	Includes full SIP messages in syslog.
Packet Capture	
Status	Displays packet capture status. When user starts to capture trace file, it will show “RUNNING” status, otherwise, it will show “STOPPED”.
With RTP Packets	Defines whether packet capture file contains RTP or not. Default setting is No .
Factory Reset	
Factory Reset	Press Reset to restore the factory default settings on the DP750.



Support	
Online Support	Redirects the users to tools page available on Grandstream official website.
Offline Support	Permits the users to download the administration and user guide and also the drilling templates.
Download Default Device Configuration	Downloads the default device configuration file in .txt and .XML formats.
Download Zero Config Template	Download the zero config templates files for UCM firmware version before and after 1.0.10.39.

Phonebook Page Definitions

Table 14: Phonebook Page Definitions

Global Phonebook XML Settings	
Global Phonebook Type	Selects type of global phonebook to use. If set to XML, DP750 will use the configuration in Global Phonebook XML Settings page. If set to LDAP, DP750 will use configuration in Global Phonebook LDAP Settings page.
Enable Automatic XML Phonebook Download	Sends periodic requests to download XML Phonebook via HTTP, HTTPS, or TFTP.
HTTP/HTTPS User Name	Enters user name to authenticate with HTTP/HTTPS server.
HTTP/HTTPS Password	Enters password to authenticate with HTTP/HTTPS server.
Phonebook XML Server Path	Indicates server path to download XML phonebook file. This field could be IP address or URL, with up to 256 characters.
Phonebook Download Interval	Sets interval to send XML phonebook download requests (in minutes). If set to 0, automatic download is disabled. Valid range is 5 to 720. Default is 5 minutes.
Remove Manually-edited Entries on Download	Deletes entries added manually when XML phonebook is downloaded. Default is No .



Import XML Phonebook	Upload: Uploads manually global XML phonebook file to the base station. Delete: Clears global XML phonebook file in the base station.
Export XML Phonebook	Downloads global XML phonebook from the base station in .xml format.

Global Phonebook LDAP Settings

Global Phonebook Type	Selects type of global phonebook to use. If set to XML, DP750 will use the configuration in Global Phonebook XML Settings page. If set to LDAP, DP750 will use configuration in Global Phonebook LDAP Settings page.
LDAP protocol	Chooses LDAP or LDAPS (LDAP over TLS) protocol. Default is LDAP .
Server Address	Configures IP address or domain name of the LDAP server.
Port	Determines LDAP server port. Default is 389 .
Base	Indicates the location in the directory where the search is requested to begin. <u>Example:</u> dc=grandstream, dc=com ou=Boston, dc=grandstream, dc=com
User Name	Binds "Username" for querying LDAP servers. Some LDAP servers allow anonymous binds in which case the setting can be left blank.
Password	Binds "Password" for querying LDAP servers. The field can be left blank if the LDAP server allows anonymous binds.
LDAP Number Filter	Configures the filter to use for number lookup. <u>Examples:</u> ((telephoneNumber=%)(Mobile=*)) returns all records which has the "telephoneNumber" or "Mobile" field starting with the entered prefix; (&(telephoneNumber=*) (cn=*)) returns all the records with the "telephoneNumber" field starting with the entered prefix and "cn" field set.
LDAP Name Filter	Configures the filter to use for name lookup. <u>Examples:</u> ((cn=*)(sn=*)) returns all records which has the "cn" or "sn" field starting with the entered prefix; (!(sn=*)) returns all the records which do not have the "sn" field starting with the



	entered prefix; (&(cn=%) (telephoneNumber=*)) returns all the records with the "cn" field starting with the entered prefix and "telephoneNumber" field set.
LDAP Version	Selects LDAP protocol version to send bind requests. Default is Version 3 .
LDAP Name Attributes	Defines name attributes of each record to be returned in the LDAP search result. This field allows users to configure multiple space separated name attributes. <u>Example:</u> gn cnsn description
LDAP Number Attributes	Defines number attributes of each record to be returned in the LDAP search result. This field allows the users to configure multiple space separated number attributes. <u>Example:</u> telephoneNumber telephoneNumber Mobile
LDAP Display Name	Determines entry information to be shown on handset's LCD. Up to 3 fields can be displayed. Example: %cn %sn %telephoneNumber
Max. Hits	Specifies maximum number of results to be returned by LDAP server. If set to 0, server will return all search results. Valid range is 1 to 3000. Default is 500 .
Search Timeout	Sets interval (in seconds) for the server to process the request and return search results to the client. Default is 30 seconds.
Sort Results	Displays results sorted. Default is No .
LDAP Lookup	Contacts LDAP server to lookup dialed number or incoming caller ID.
Lookup Display Name	Displays entry information when LDAP looks up the name for incoming call or outgoing call. This field must be a subset of the LDAP Name Attributes. <u>Example:</u> gn cnsn description

Private Phonebook Settings

Phonebook Name	Defines private phonebook name.
Import XML Phonebook	Upload: Uploads manually private XML phonebook file to the base station. Delete: Clears private XML phonebook file in the base station
Export XML Phonebook	Downloads private XML phonebook from the base station in .xml format.



Change Base Station Admin PIN code

For security reasons, advanced settings in DP750 base station cannot be accessed from DP720 handset except if Admin PIN code is provided. By default, Admin PIN code is 0000.

We strongly recommend changing your Admin PIN code following below steps:

1. Access your DP750 base station web UI by entering its IP address in your favorite browser.
2. Enter your admin password (default: admin).
3. Press **Login** to access your settings.
4. Go to **DECT > General Settings** tab.
5. Enter your new **Admin PIN Code** (only digits accepted) in appropriate field.
6. Press **Save and Apply** to save your settings.

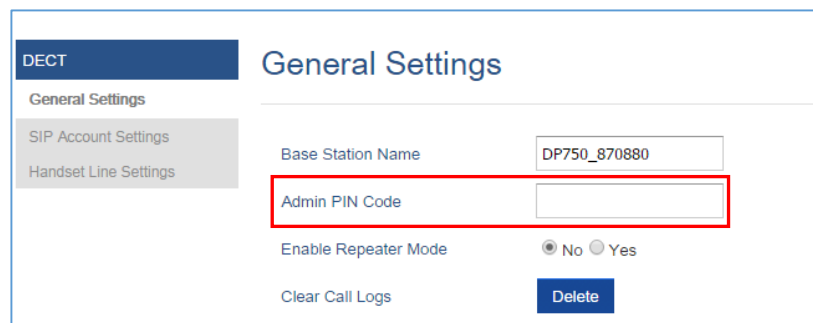

The screenshot shows the 'DECT General Settings' page. On the left is a navigation menu with 'General Settings' selected. The main content area has the following fields:

- Base Station Name: DP750_870880
- Admin PIN Code: (empty field, highlighted with a red border)
- Enable Repeater Mode: Radio buttons for 'No' (selected) and 'Yes'
- Clear Call Logs: A 'Delete' button

Figure 12: Admin PIN Code

Register DP720 Handset to DP750 Base Station

1. On DP750 Base station, press and hold the Radio/Page button for 7 seconds until the Radio icon starts blinking to start Subscription process. Or Access web UI, go to **Status > DECT Status** and press **Subscribe** button to **Open Subscription**.

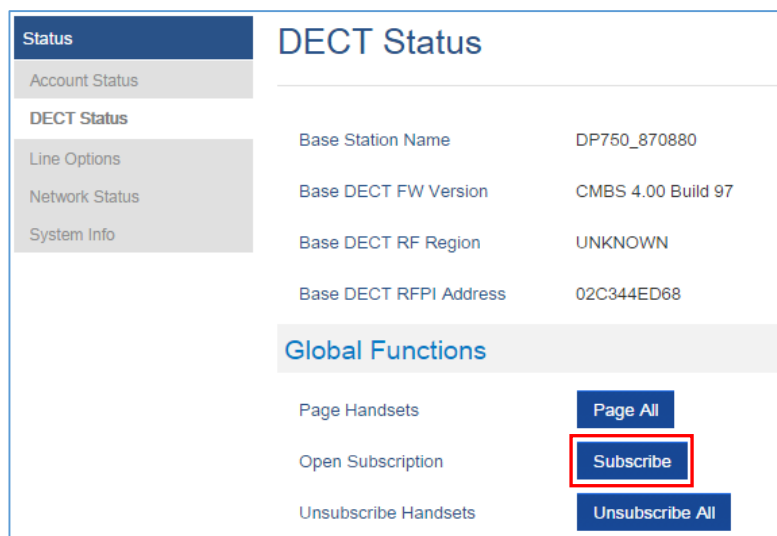



The screenshot shows the 'Status DECT Status' page. On the left is a navigation menu with 'DECT Status' selected. The main content area displays the following information:

- Base Station Name: DP750_870880
- Base DECT FW Version: CMBS 4.00 Build 97
- Base DECT RF Region: UNKNOWN
- Base DECT RFPI Address: 02C344ED68

Below this information is a section titled 'Global Functions' with three buttons:

- Page Handsets: Page All
- Open Subscription: **Subscribe** (highlighted with a red border)
- Unsubscribe Handsets: Unsubscribe All

Figure 13: DECT Status – Subscribe

2. On DP720, press “Menu” (left softkey  or the selection key ) to bring up operation menu.
3. Press arrow keys to move the cursor to **Settings** and then press “Select”.
4. Navigate to **Registration**, then press “Select” (left softkey).
5. Navigate to **Register**, then press “Select” while the DP750 Radio icon is blinking.
6. Select **BaseX** (X=1-4) corresponding to the desired base station DP750, then press **Subscribe**.
7. The DP720 will search for nearby base stations and will display the RFPI code and Base station name of the discovered DP750.
8. Press **Subscribe** to pair with the displayed DP750.
9. The DP720 will display **Easy Pairing** on the LCD and play an audible buzz when successful. Then it will return to the home screen, displaying the handset name and number assigned by the registered base station.

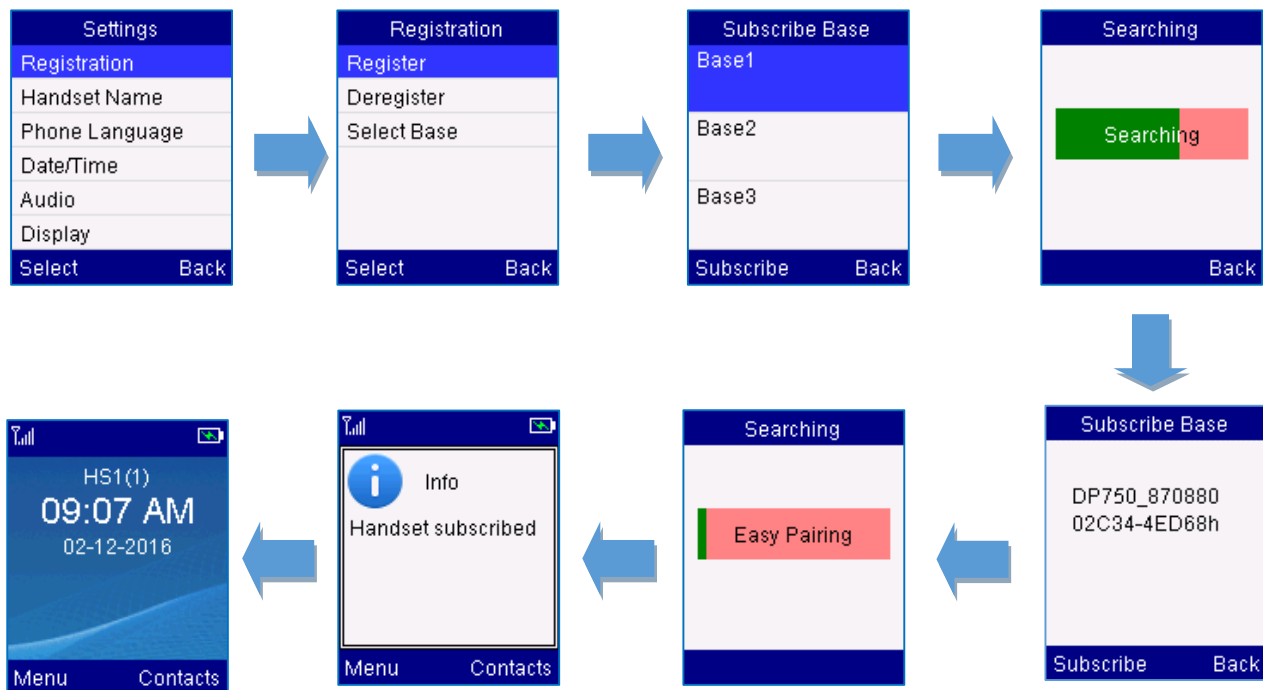

Figure 14: Registration Process



Using DP720 with Multiple DP750 Base Stations

DP720 is able to be registered to up four different DP750 base stations.



Registering DP720 to an additional DP750 base station

Considering DP720 is previously registered to an initial base station, please follow below steps to register a handset to an additional base station:

1. Press **Menu** (left softkey  or the selection key ) to bring up operation menu.
2. Use arrow keys to reach **Settings**  .
3. Select **Registration**.
4. Select **Register**.
5. Navigate to an unsubscribed Base using arrow keys, and click on **Subscribe**.
6. Make sure that the subscription is opened on the new base station.

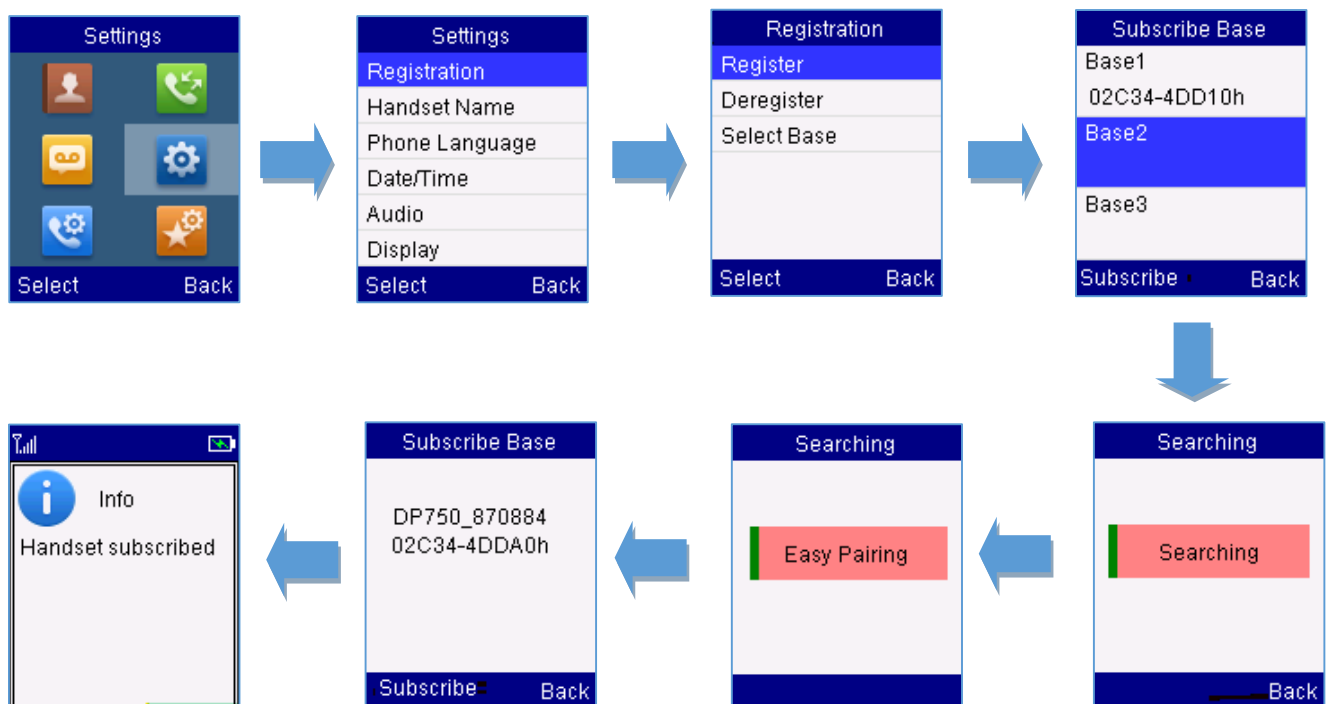





Figure 15: Multiple Base Stations Registration

Switching Between Different Base Stations

1. Press "Menu" (left softkey  or the selection key ) to bring up operation menu.
2. Use arrow keys to reach **Settings**  .



3. Select **Registration**.
4. Navigate to **Select Base** using arrow keys.
5. Select the desired base station and press **Select**.

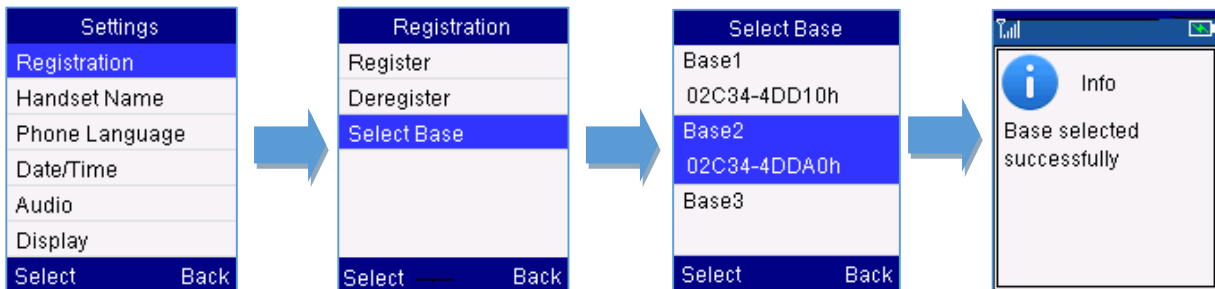



Figure 16: Switching Between Base Stations

Unregister the DP720

1. On DP720, press “Menu” (left softkey  or the selection key ) to bring up operation menu.
2. Press arrow keys to move the cursor to **Settings** and then press “Select”.
3. Navigate to **Registration**, then press “Select” (left softkey).
4. Navigate to **Deregister**.
5. Select the Handset to be unregistered and press “Deregister” (left softkey).
6. Enter the system PIN (default: 0000).
7. Press “Done” (left softkey) to confirm or “Back” (right softkey) to cancel.

Locating a DP720 Handset from DP750 Base station

In some situations, you may have a DP720 handset incorrectly positioned and you don't know its current location. You can locate a DP720 handset from his registered DP750 base station using below steps:

Locate via DP750 Web UI

1. Access your DP750 base station web UI by entering its IP address in your favorite browser.
2. Enter your admin password (default: admin).
3. Press **Login** to access your settings.
4. Go to **Status > DECT Status** tab.
5. Choose which handset to locate and press its corresponding **Page** button.
6. A paging call will be received on the selected DP720 handset.

If you press **Page All**, all registered DP720 handsets will be receiving paging call.

7. Once located, you can press any key on the handset or press **Page** or **Page All** to end paging call.



Status

Account Status

DECT Status

Line Options

Network Status

System Info

DECT Status

Base Station Name	DP750_870880
Base DECT FW Version	CMBS 4.00 Build 97
Base DECT RF Region	UNKNOWN
Base DECT RFPI Address	02C344ED68

Global Functions

Page Handsets	Page All
Open Subscription	Subscribe
Unsubscribe Handsets	Unsubscribe All

Handset Status

Handset Name	IPEI		Page	Unsubscribe	HS Firmware	Upgrade
HS1	HS1	02C332AAB7	Page	Unsubscribe	1.0.2.16	Up to date
HS2	HS2	02C332AA67	Page	Unsubscribe	1.0.2.16	Up to date
HS3	HS3	NOT SUBSCRIBED				
HS4	HS4	NOT SUBSCRIBED				
HS5	HS5	NOT SUBSCRIBED				

Figure 17: Locate Handset via Web UI

Locate via DP750 Base station

1. On DP750 Base station back side, press **Radio/Page** button  .
2. All registered handsets will receive Paging call.
3. Once located, you can end the paging calling by pressing any key on the handsets or by pressing again **Radio/Page** button.

Register a SIP Account

DP750 supports up to 10 SIP accounts, 5 handsets. Each Handset can be configured up to 10 accounts. Please be aware that line settings will be affected by DID settings (hunting up settings) in “DECT - SIP Account Settings”.

Register account via web user interface

1. Access your DP750 base station web UI by entering its IP address in your favorite browser.
2. Enter your admin password (default: admin).
3. Press **Login** to access your settings.
4. Go to **Profiles** tab and select a profile to use.



DP750 supports up to 4 profiles. A profile is a set of settings including general settings, network settings, SIP setting, audio setting, call settings and ring tones, and etc.

A profile can be used with different SIP accounts.

5. In **General Settings**, set the following:
 - a. **Profile Active** to **Yes**.
 - b. **SIP Server** field with your SIP server IP address or FQDN.
 - c. **Failover SIP Server** with your Failover SIP Server IP address or FQDN. Leave empty if not available.
 - d. **Prefer Primary SIP Server** to **No** or **Yes** depending on your configuration. Set to **No** if no Failover SIP Server is defined. If “**Yes**”, account will register to Primary SIP Server when failover registration expires.
 - e. **Outbound Proxy** with your Outbound Proxy IP Address or FQDN. Leave empty if not available.

For more information, related to above options please refer to [Technical Information table](#)

6. Press **Save and Apply** to save your configuration.

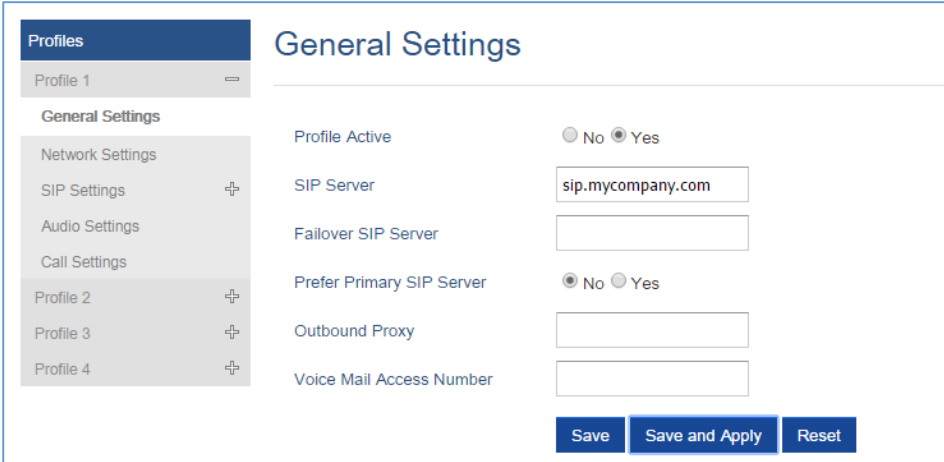
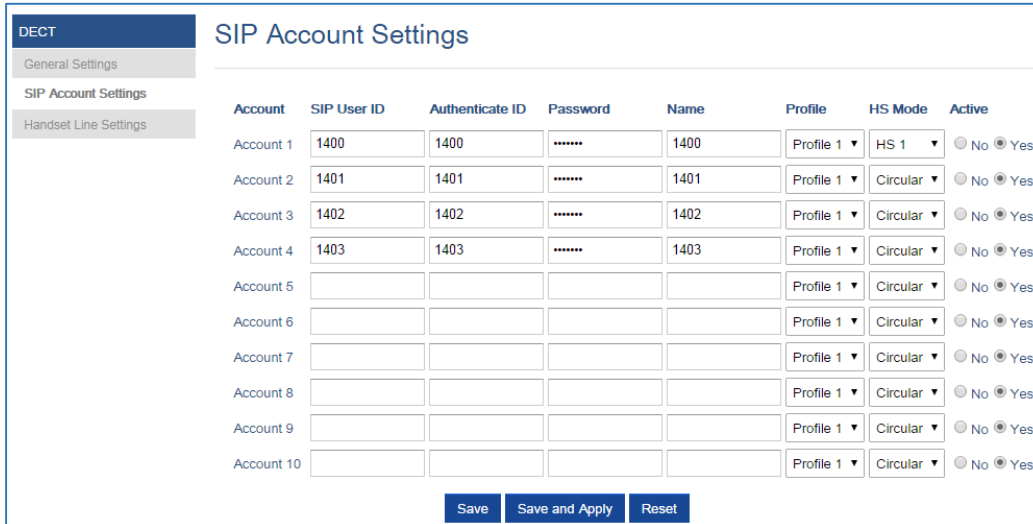

Figure 18: SIP Settings

7. Go to **DECT >SIP Account Settings**
8. Configure your SIP details in desired account:
 - a. **Account:** Select Account row to configure (Account 1 – Account 10).
 - b. **SIP User ID:** User account information, provided by VoIP service provider (ITSP). Usually in the form of digit similar to phone number or actually a phone number.
 - c. **Authenticate ID:** SIP service subscriber’s Authenticate ID used for authentication. Can be identical to or different from SIP User ID.
 - d. **Password:** SIP service subscriber’s account password to register to SIP server of ITSP. For security reasons, the password will field will be shown as empty.

- e. **Name:** Any name to identify this specific user.
 - f. **Profile:** Select the corresponding Profile ID (1/2/3/4).
 - g. **HS Mode:** Assign the account to specific handset (HS1, HS2...) or hunting group mode.
 - h. **Active:** Set to **Yes**. If set to **No**, account is disabled and will not register.
9. Press **Save and Apply** to save your configuration.



The screenshot shows the 'SIP Account Settings' page. On the left, there is a navigation menu with 'DECT' selected, and sub-items for 'General Settings', 'SIP Account Settings', and 'Handset Line Settings'. The main area contains a table with 10 rows for 'Account 1' through 'Account 10'. Each row has columns for 'SIP User ID', 'Authenticate ID', 'Password', 'Name', 'Profile', 'HS Mode', and 'Active'. The first four accounts are pre-filled with values: Account 1 (1400, 1400, Password, 1400), Account 2 (1401, 1401, Password, 1401), Account 3 (1402, 1402, Password, 1402), and Account 4 (1403, 1403, Password, 1403). At the bottom of the table are three buttons: 'Save', 'Save and Apply', and 'Reset'.

Figure 19: Sip Accounts Settings

After applying your configuration, your phone will register to your SIP Server.

You can verify if your DECT phone has registered with your SIP server from your DP750 web interface under **Status > Account Status** (a green background with Yes under SIP Registration column for corresponding account indicates the account(s) has been successfully registered).

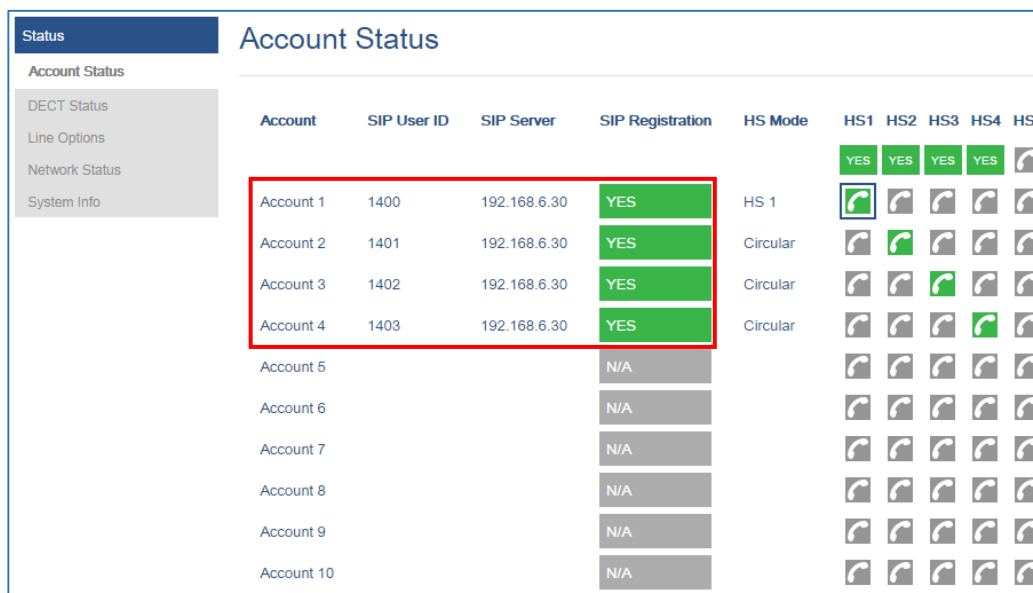

The screenshot shows the 'Account Status' page. On the left, there is a navigation menu with 'Status' selected, and sub-items for 'Account Status', 'DECT Status', 'Line Options', 'Network Status', and 'System Info'. The main area contains a table with 10 rows for 'Account 1' through 'Account 10'. The table has columns for 'Account', 'SIP User ID', 'SIP Server', 'SIP Registration', 'HS Mode', and five handset status columns (HS1, HS2, HS3, HS4, HS5). The first four accounts (1-4) have a green background in the 'SIP Registration' column and a green handset icon in the 'HS1' column. The remaining accounts (5-10) have a grey background and 'N/A' in the 'SIP Registration' column. A red box highlights the first four rows of the table.

Account	SIP User ID	SIP Server	SIP Registration	HS Mode	HS1	HS2	HS3	HS4	HS5
Account 1	1400	192.168.6.30	YES	HS 1	📞	📞	📞	📞	📞
Account 2	1401	192.168.6.30	YES	Circular	📞	📞	📞	📞	📞
Account 3	1402	192.168.6.30	YES	Circular	📞	📞	📞	📞	📞
Account 4	1403	192.168.6.30	YES	Circular	📞	📞	📞	📞	📞
Account 5			N/A		📞	📞	📞	📞	📞
Account 6			N/A		📞	📞	📞	📞	📞
Account 7			N/A		📞	📞	📞	📞	📞
Account 8			N/A		📞	📞	📞	📞	📞
Account 9			N/A		📞	📞	📞	📞	📞
Account 10			N/A		📞	📞	📞	📞	📞

Figure 20: Account Status

Multiple Lines and Hunting Groups

The DP750 Base Station has the ability to assign 10 lines to each registered DP720 handset (Up to 5 Handsets) to receive/make calls.

When a Handset has many lines configured, users can select specific line for outgoing calls using **Outgoing Default Line** feature.

For incoming calls, users can choose either to redirect them to a specific Handset or to many using Hunting Group feature so to have the same phone number and incoming calls will be distributed in a Linear, Circular, Parallel or Shared manner among the handsets active in that Hunting Group. The number of hunting groups is limited by the number of SIP accounts registered to the base station (up to 10 accounts). Hunting group feature is mainly used in office, warehouse and call center environments to distribute incoming calls in the best way depending on the type of hunt group.

In order to configure hunting groups for DP720 Handsets registered to the Base, users need first to register SIP accounts on DP750 Base Station **SIP Account Settings** and then assign accounts accordingly as lines for DP720 Handsets **Handset Line Settings**.

Handset Line Settings

This section will describe how to assign lines for each DP720 Handset for making calls.

1. Access your DP750 base station web UI by entering its IP address in your favorite browser.
2. Enter your admin password (default: admin).
3. Press Login to access your settings.
4. Go to **DECT > Handset Line Settings**, and assign to Handsets the SIP accounts already configured. Each handset can be configured to use up to 10 sip accounts.

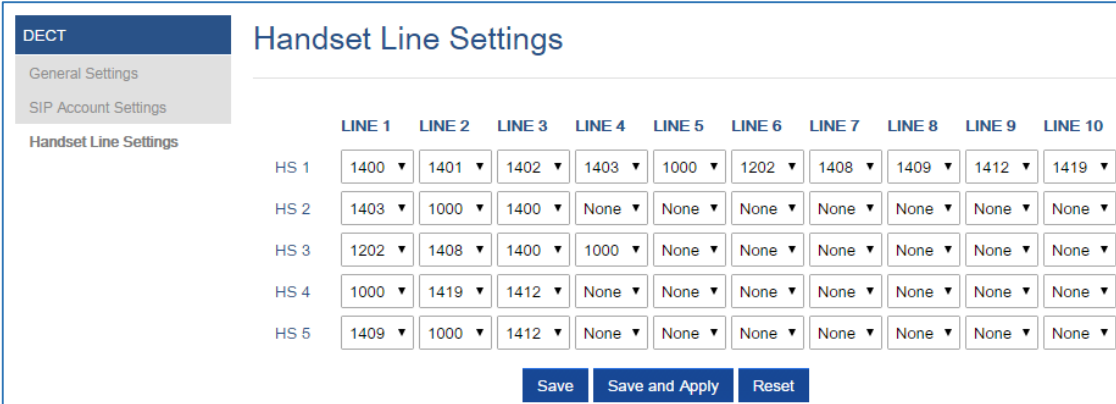

	LINE 1	LINE 2	LINE 3	LINE 4	LINE 5	LINE 6	LINE 7	LINE 8	LINE 9	LINE 10
HS 1	1400	1401	1402	1403	1000	1202	1408	1409	1412	1419
HS 2	1403	1000	1400	None	None	None	None	None	None	None
HS 3	1202	1408	1400	1000	None	None	None	None	None	None
HS 4	1000	1419	1412	None	None	None	None	None	None	None
HS 5	1409	1000	1412	None	None	None	None	None	None	None

Figure 21: Handset Line Settings

After applying your configuration, **Account Status** page will display the status of handsets along with accounts status. Each column shows one HS; each row shows if the account is assigned to a HS.

For example: If the account 1, 4 and 5 are assigned to the HS2, the column of HS2 will have cells 1, 4 and 5 in green background, account 2, 3, 6,7,8,9 and 10 are in gray background. If a line is being used it will be blinking in a green / white background, for example HS5 is on call using line 8. See Figure 20.

Status		Account Status									
Account Status		Account	SIP User ID	SIP Server	SIP Registration	HS Mode	HS1	HS2	HS3	HS4	HS5
DECT Status		Account 1	1400	192.168.6.30	YES	HS 1					
Line Options		Account 2	1401	192.168.6.30	YES	Circular					
Network Status		Account 3	1402	192.168.6.30	YES	Circular					
System Info		Account 4	1403	192.168.6.30	YES	Circular					
		Account 5	1000	192.168.6.30	YES	Circular					
		Account 6	1202	192.168.6.30	YES	Circular					
		Account 7	1408	192.168.6.30	YES	Circular					
		Account 8	1409	192.168.6.30	YES	Circular					
		Account 9	1412	192.168.6.30	YES	Circular					
		Account 10	1419	192.168.6.30	YES	Circular					

Figure 22: Account Status – Line Status

Outgoing Default Line

When a Handset is configured with more than one line, users can change the default outgoing line on DP720 Handset using keypad **Menu > Call Settings**  **> Outgoing Default Line**, see next screenshot

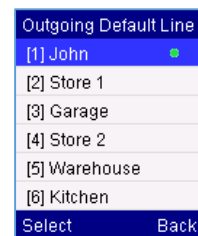

Hunting Groups

DP750 supports 4 types of hunting groups as described below:

In the examples below, we consider that all handsets are in same hunting group and only the type of hunting group differs.

- **Circular:** The base station will note which handset answered the last call, and forward the call to the next available handset in round-robin fashion.

In the example below; the 1st incoming call was sent to HS1 since all handsets were available; 2nd incoming call will be sent to HS2 since previous call was answered by HS1 and HS2 is the next available handset in the list; 3rd will be sent to HS4 since HS2 was the last one answering the call and HS3 is busy making an outgoing call (if HS3 was available, the call will be sent to HS3).

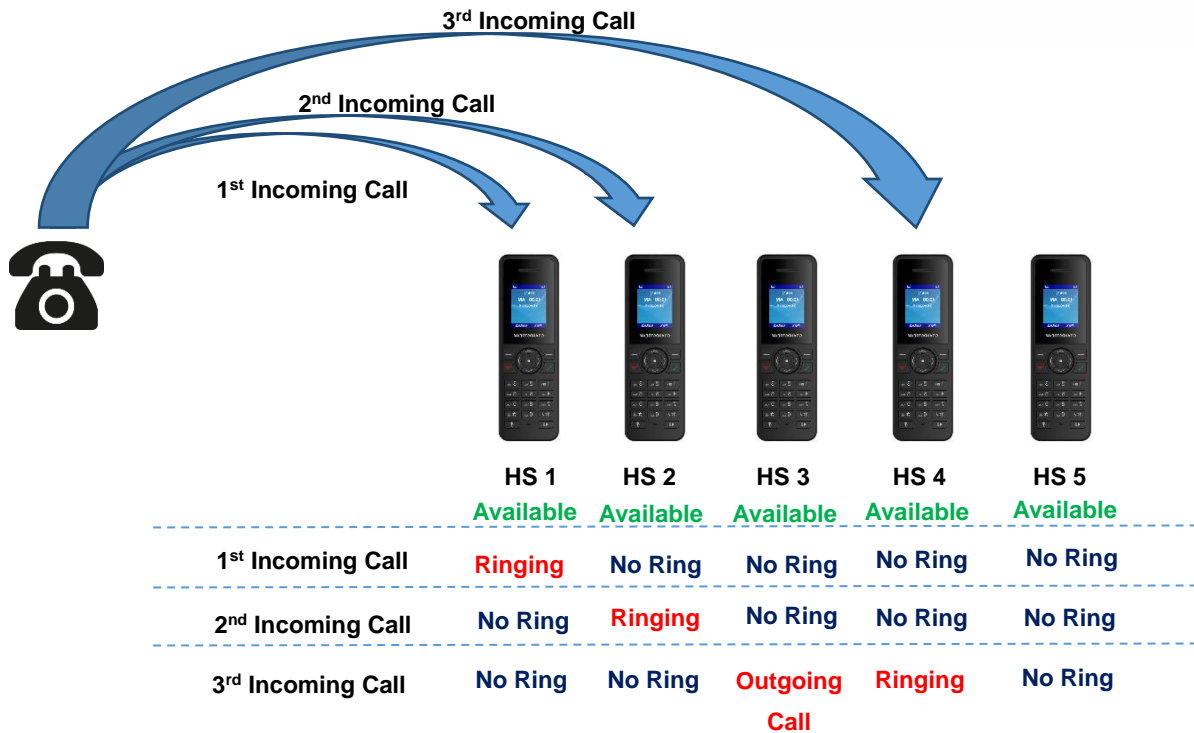

- **Linear:** The base station will distribute the call in predefined order from the lowest-numbered available handset, if no answer within ring timeout, the call will be sent to next available handset in sequence. This mode is also called “serial hunting”.

In the example below; all handsets are available, the incoming call will be sent to HS1 since it's the lowest-numbered available handset, if no answer within ring timeout, the call will be sent to HS2 since it's the next available lowest-numbered handset, and same applies for HS3 and etc.

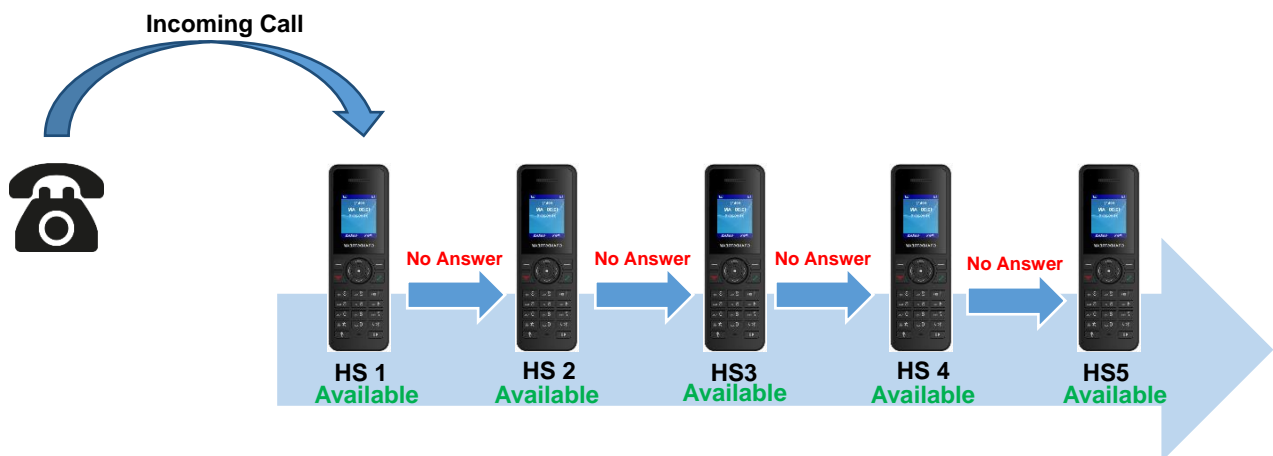

- **Parallel:** In this mode, all phones ring concurrently. If one phone answers, the remaining available phones can make new outgoing calls.

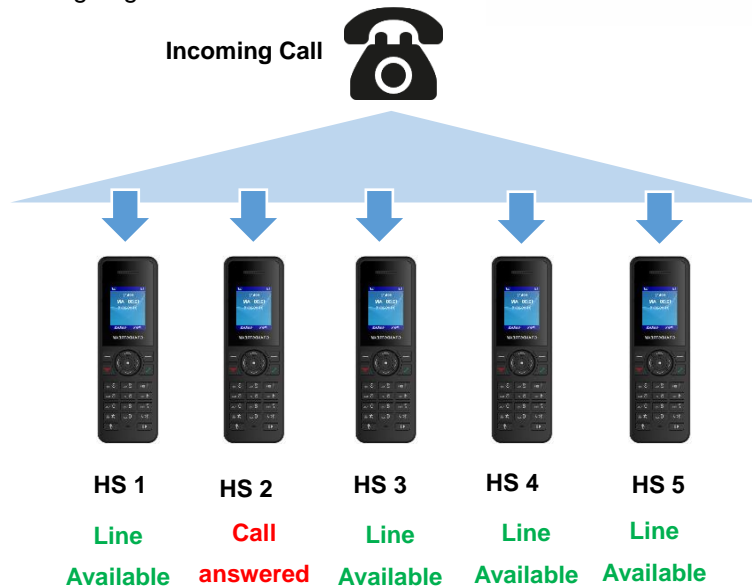

- **Shared:** In this mode, all phones ring concurrently. The handsets always share the same line, so if one answers the call; none of the other handsets will be able to make outgoing call since the line is busy at that time.

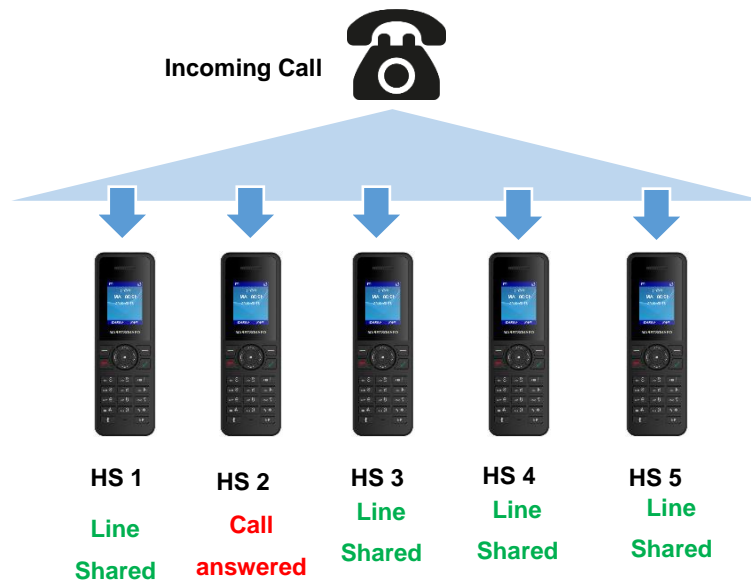

This section will describe how to configure hunting groups for incoming calls:

Below steps are considering that SIP accounts were previously registered.

1. Access your DP750 base station web UI by entering its IP address in your favorite browser.
2. Enter your admin password (default: admin).
3. Press **Login** to access your settings.



4. Go to **DECT > SIP Account Settings**.
5. Set **HS Mode** depending on your needs to configure your hunting groups.
6. Press **Save and Apply** to save your settings.

Example:

In the example below Account 9 (1412) is assigned to HS1, HS4 and HS5, and the hunting group (**HS Mode**) is set to Parallel, so incoming calls to that account will make HS1,HS4 and HS5 ring simultaneously, and when one of the Handsets answers, the remaining two will be able to make or receive new calls using that account.

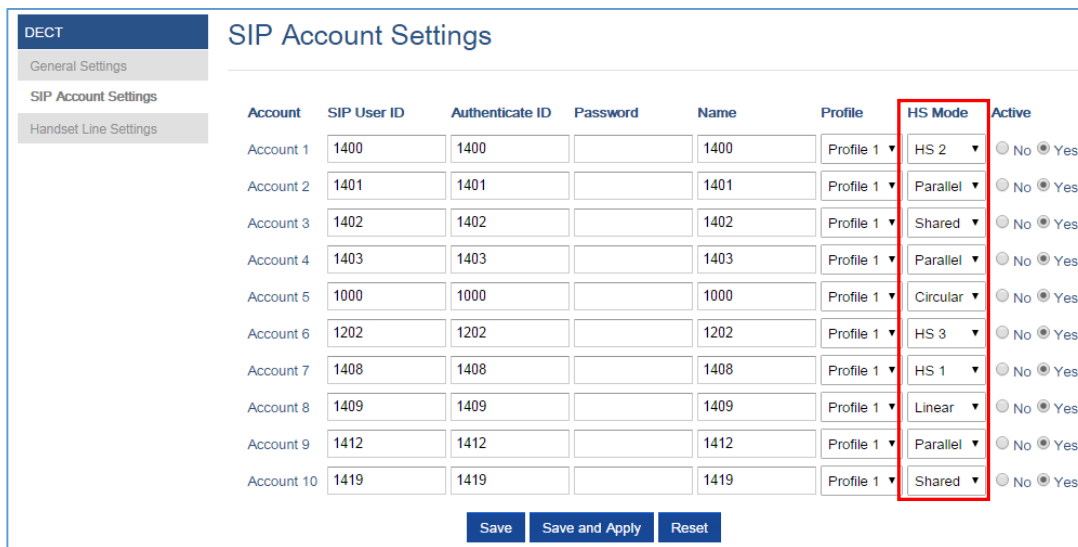

Account	SIP User ID	Authenticate ID	Password	Name	Profile	HS Mode	Active
Account 1	1400	1400		1400	Profile 1	HS 2	<input type="radio"/> No <input checked="" type="radio"/> Yes
Account 2	1401	1401		1401	Profile 1	Parallel	<input type="radio"/> No <input checked="" type="radio"/> Yes
Account 3	1402	1402		1402	Profile 1	Shared	<input type="radio"/> No <input checked="" type="radio"/> Yes
Account 4	1403	1403		1403	Profile 1	Parallel	<input type="radio"/> No <input checked="" type="radio"/> Yes
Account 5	1000	1000		1000	Profile 1	Circular	<input type="radio"/> No <input checked="" type="radio"/> Yes
Account 6	1202	1202		1202	Profile 1	HS 3	<input type="radio"/> No <input checked="" type="radio"/> Yes
Account 7	1408	1408		1408	Profile 1	HS 1	<input type="radio"/> No <input checked="" type="radio"/> Yes
Account 8	1409	1409		1409	Profile 1	Linear	<input type="radio"/> No <input checked="" type="radio"/> Yes
Account 9	1412	1412		1412	Profile 1	Parallel	<input type="radio"/> No <input checked="" type="radio"/> Yes
Account 10	1419	1419		1419	Profile 1	Shared	<input type="radio"/> No <input checked="" type="radio"/> Yes

Figure 23: Hunting Group configuration

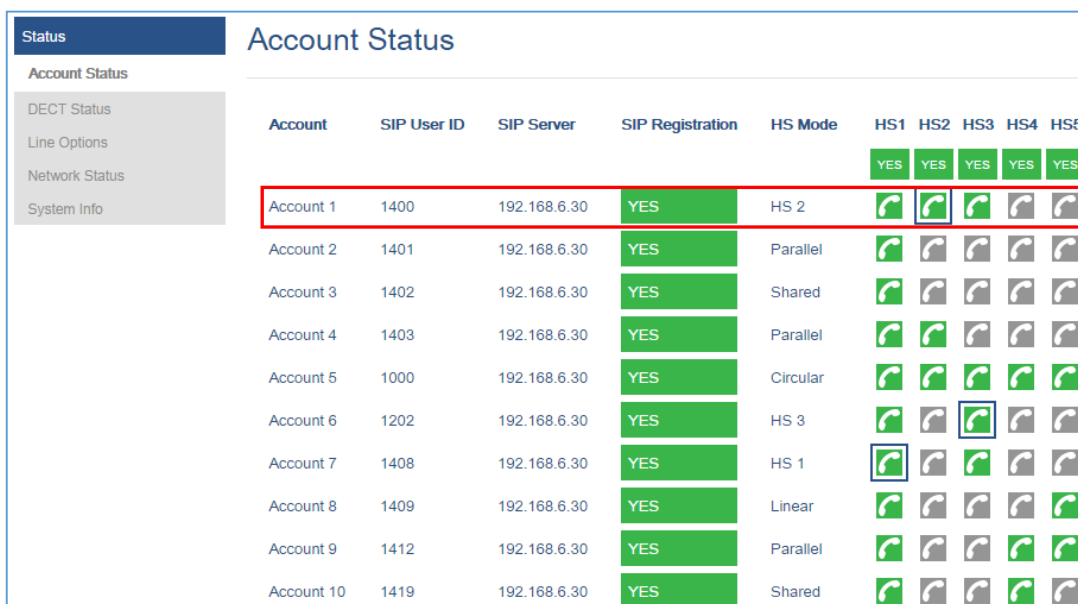

Account	SIP User ID	SIP Server	SIP Registration	HS Mode	HS1	HS2	HS3	HS4	HS5
Account 1	1400	192.168.6.30	YES	HS 2					
Account 2	1401	192.168.6.30	YES	Parallel					
Account 3	1402	192.168.6.30	YES	Shared					
Account 4	1403	192.168.6.30	YES	Parallel					
Account 5	1000	192.168.6.30	YES	Circular					
Account 6	1202	192.168.6.30	YES	HS 3					
Account 7	1408	192.168.6.30	YES	HS 1					
Account 8	1409	192.168.6.30	YES	Linear					
Account 9	1412	192.168.6.30	YES	Parallel					
Account 10	1419	192.168.6.30	YES	Shared					

Figure 24: Hunting Group Status



Configuration via Keypad

To configure the LCD menu using DP720's keypad, follow the instructions below:

- Register the DP720 to DP750. Please see [Register DP720 Handset to DP750 Base Station](#);
- **Enter/Confirm/ selection.** Press the left softkey, right softkey, on-hook key or OK/Select key to enter the selected option, back to last layer or exit;
- **Exit.** Press “right softkey” to exit to the previous menu;
- **Return to Home page.** Press “On-hook” key to exit to the main menu.
- The DP720 automatically exits to main mode with an incoming call, when the phone is off hook or left idle for more than 20 seconds.
- When the phone is in idle, pressing the DOWN navigation key can enter the **Outgoing call log**. Please refer to [DP720 Handset Menu Structure](#) for more details.



Call Features

The DP750/DP720 supports traditional and advanced telephony features including caller ID, caller ID with caller Name, call forward and etc.

Table 15: Call Features

*30	Block Caller ID (for all subsequent calls) <ul style="list-style-type: none"> • Off hook the phone; • Dial *30.
*31	Send Caller ID (for all subsequent calls) <ul style="list-style-type: none"> • Off hook the phone; • Dial *31.
*50	Disable Call Waiting <ul style="list-style-type: none"> • Off hook the phone; • Dial *50.
*51	Enable Call Waiting <ul style="list-style-type: none"> • Off hook the phone; • Dial *51.
*67	Call with Caller ID Blocked (per call) <ul style="list-style-type: none"> • Off hook the phone; • Dial *67 and then enter the number to dial out.
*82	Call with Caller ID Enabled (per call) <ul style="list-style-type: none"> • Off hook the phone; • Dial *82 and then enter the number to dial out.
*70	Call with Call Waiting Disable (per Call) <ul style="list-style-type: none"> • Off hook the phone; • Dial *70 and then enter the number to dial out.
*71	Call with Call Waiting Enabled (per Call) <ul style="list-style-type: none"> • Off hook the phone; • Dial *71 and then enter the number to dial out.
*72	Unconditional Call Forward. To set up unconditional call forward: <ul style="list-style-type: none"> • Off hook the phone; • Dial *72 and then enter the number to forward the call; • Press “OK” softkey or SEND key.



*73	<p>Cancel Unconditional Call Forward. To cancel the unconditional call forward:</p> <ul style="list-style-type: none"> • Off hook the phone; • Dial *73; • Hang up the call.
*90	<p>Busy Call Forward. To set up busy call forward:</p> <ul style="list-style-type: none"> • Off hook the phone; • Dial *90 and then enter the number to forward the call; • Press “OK” softkey or SEND key.
*91	<p>Cancel Busy Call Forward. To cancel the busy call forward:</p> <ul style="list-style-type: none"> • Off hook the phone; • Dial *91; • Hang up the call.
*92	<p>Delayed Call Forward. To set up delayed call forward:</p> <ul style="list-style-type: none"> • Off hook the phone; • Dial *92 and then enter the number to forward the call; • Press “OK” softkey or SEND key.
*93	<p>Cancel Delayed Call Forward. To cancel the delayed call forward:</p> <ul style="list-style-type: none"> • Off hook the phone; • Dial *93; • Hang up the call.

DP750 Phonebook Management

DP750/720 support Private and Shared Phonebooks; both phonebook types can be used at same time:

Private Phonebook

Private phonebook allows you to manage your contacts on each registered handset; each handset can have his own private phonebook with his own contacts. DP750 supports up to 5 private phonebooks. A private phonebook can be assigned to one or more handsets registered to the base.

Below steps explain how upload your private phonebook and assign it to a specific handset:

1. Access your DP750 base station web UI by entering its IP address in your favorite browser.
2. Enter your admin password (default: admin).
3. Press **Login** to access your settings.
4. Go to **Phonebook > Private Phonebook Settings**.



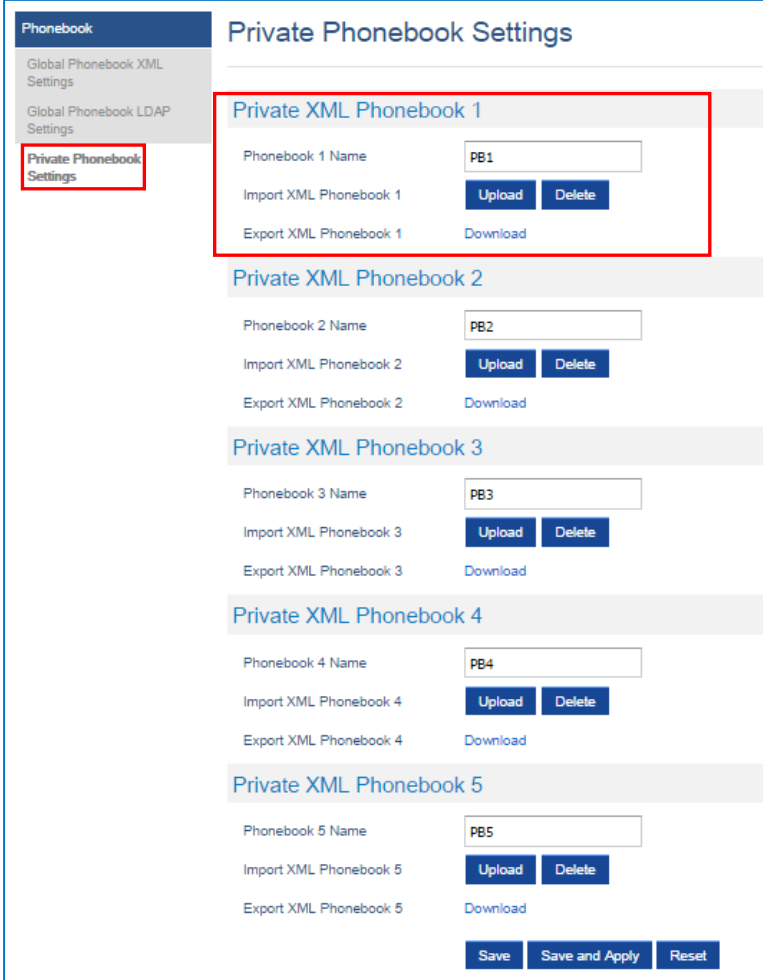

Phonebook

- Global Phonebook XML Settings
- Global Phonebook LDAP Settings
- Private Phonebook Settings**

Private Phonebook Settings

Private XML Phonebook 1

Phonebook 1 Name:

Import XML Phonebook 1:

Export XML Phonebook 1:

Private XML Phonebook 2

Phonebook 2 Name:

Import XML Phonebook 2:

Export XML Phonebook 2:

Private XML Phonebook 3

Phonebook 3 Name:

Import XML Phonebook 3:

Export XML Phonebook 3:

Private XML Phonebook 4

Phonebook 4 Name:

Import XML Phonebook 4:

Export XML Phonebook 4:

Private XML Phonebook 5

Phonebook 5 Name:

Import XML Phonebook 5:

Export XML Phonebook 5:

Figure 25: Private Phonebook Settings

5. In **Private XML Phonebook X** section (X from 1 to 5):
 - a. Enter **Phonebook X Name** (default value is PB1 for first handset, PB2 for second handset...).
 - b. Press **Upload** button to **Import XML Phonebook X**.
 - c. Browse your computer files and select your desired **phonebook.xml** file.
 - d. Press **Save and Apply** to save your settings.
6. Go to **DECT > General Settings** tab.
7. In **Handset Settings** section, select your **Handset Phonebook** to assign it to a specific handset as shown below where **PB1** is assigned to **HS1**, **PB2** is assigned to **HS2**...

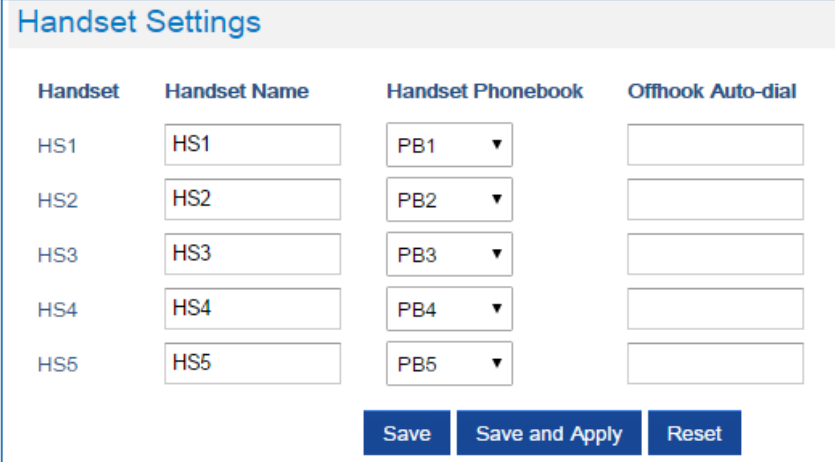

Handset	Handset Name	Handset Phonebook	Offhook Auto-dial
HS1	HS1	PB1 ▼	
HS2	HS2	PB2 ▼	
HS3	HS3	PB3 ▼	
HS4	HS4	PB4 ▼	
HS5	HS5	PB5 ▼	

Save Save and Apply Reset

Figure 26: Handset Phonebook Settings

You can assign same Private Phonebook to more than one handset.

For example, we can assign **Handset Phonebook** named **PB1** to **HS1** and **HS2**.

Any change in **PB1** contacts will be applied to both **HS1** and **HS2** private phonebooks.

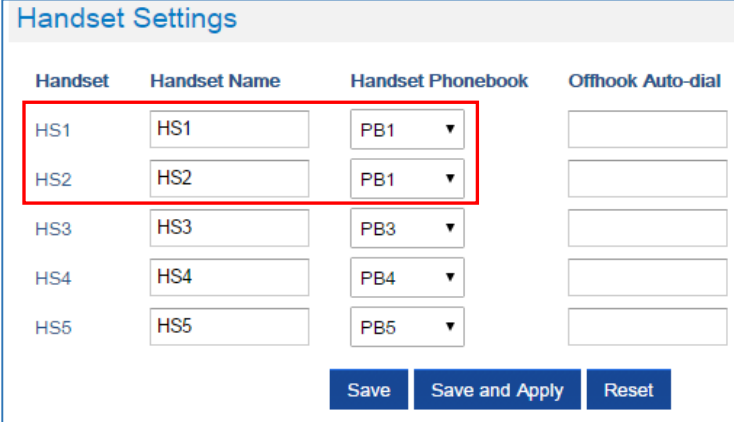

Handset	Handset Name	Handset Phonebook	Offhook Auto-dial
HS1	HS1	PB1 ▼	
HS2	HS2	PB1 ▼	
HS3	HS3	PB3 ▼	
HS4	HS4	PB4 ▼	
HS5	HS5	PB5 ▼	

Save Save and Apply Reset

Figure 27: Handset Phonebook Selection

- Press **Save and Apply** to save your configuration.

After applying your configuration, your DP720 handset will display uploaded phonebook contacts. You can access your private phonebook by pressing **Contacts** on your DP720 handset and select **Private**. Your Private Phonebook contacts will be loaded and displayed on your DP720 screen.

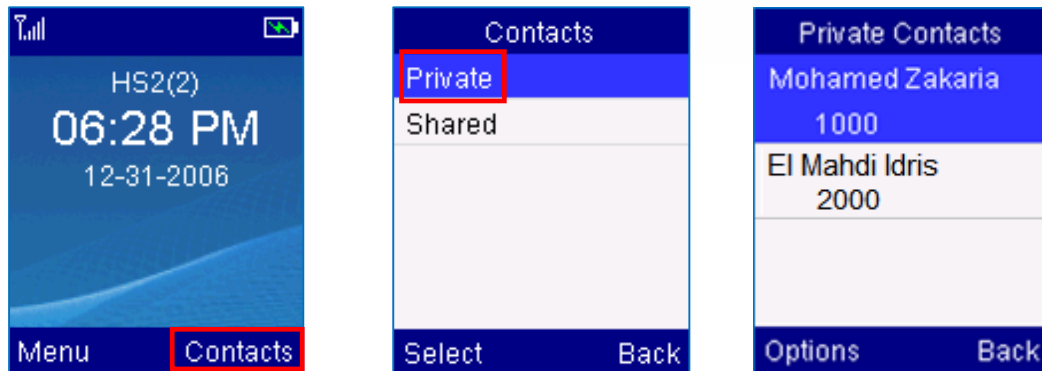

Global Phonebook

Global phonebook allows you to manage your contacts and use them in all registered handsets.

Global phonebook contacts can be imported either via XML or via LDAP.

Below steps explain how upload your shared phonebook:

Global Phonebook via XML

1. Access your DP750 base station web UI by entering its IP address in your favorite browser.
2. Enter your admin password (default: admin).
3. Press **Login** to access your settings.
4. Go to **Phonebook > Global Phonebook XML Settings** tab.
5. Set **Global Phonebook Type** to **XML** (in this case, LDAP phonebook will not be available).

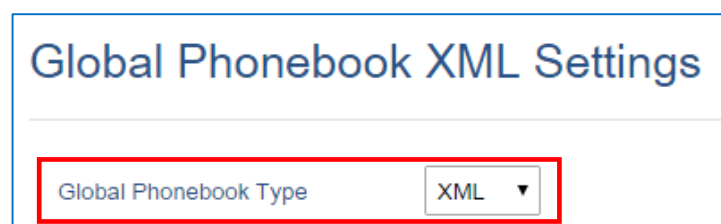

Figure 28: Global Phonebook XML Settings

6. There are two methods to import/download your XML Phonebook:
 - a. **Automatic XML Phonebook Download**
 For this method, you need to use a TFTP or HTTP or HTTPS server and make your phonebook.xml file available in your preferred server.
 - i. Set **Enable Automatic XML Phonebook Download** to **Enabled**, use **TFTP/HTTP or HTTPS** depending on your server.



- ii. If using HTTP or HTTPS server and User Name and Password are required to connect to the server, set **HTTP/HTTPS User Name** and **HTTP/HTTPS Password** fields with appropriate values.
- iii. Configure **Phonebook XML Server Path** field. This field could be IP address or URL, with up to 256 characters. The phone will request file named **phonebook.xml** from provided directory. Example: *192.168.5.1/Directory*
- iv. Configure the **Phonebook Download Interval** (in minutes) to periodically contact your server to download new phonebook file version if available. If set to 0, automatic download will be disabled. Valid range is 5 to 720.
- v. Set **Remove Manually-edited Entries on Download** to **No** to keep any contact information entered from the handset directly while downloading your global phonebook file, otherwise, if set to **Yes**, any contact manually entered from the handset will be removed while downloading your global phonebook file.

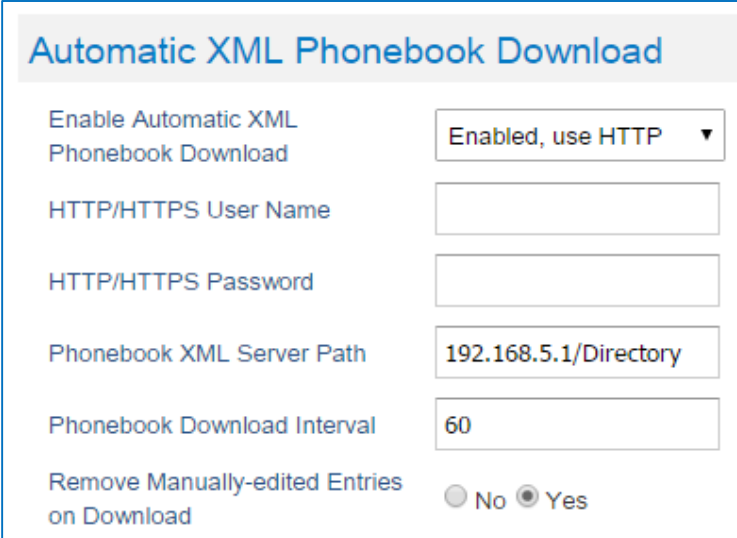

Figure 29: Automatic XML Phonebook Download

b. Manual XML Phonebook Management

- i. Press **Upload** in **Import XML Phonebook**.
- ii. Browse your files and select your **phonebook.xml** file.

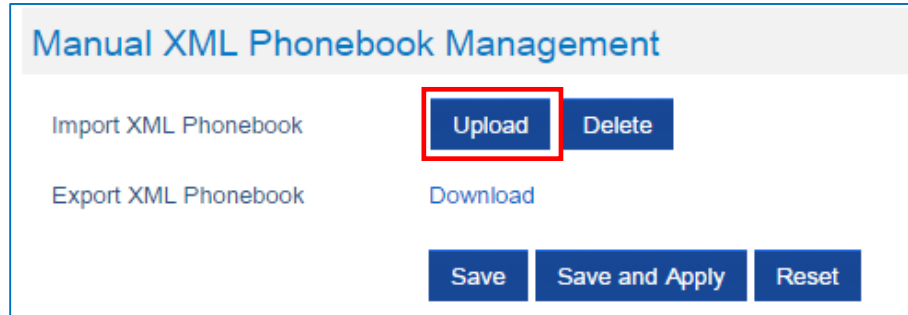

Figure 30: Manual XML Phonebook Management

XML Phonebook file format

```
<?xml version="1.0" encoding="UTF-8"?>
<AddressBook>
  <Contact>
    <FirstName>First name</FirstName>
    <LastName>Last name</LastName>
    <Ringtone>Ringtone ID (default 0)</Ringtone>
    <Phone type="Home">
      <phonenumber>Home phone number</phonenumber>
    </Phone>
    <Phone type="Work">
      <phonenumber>Work phone number</phonenumber>
    </Phone>
    <Phone type="Mobile">
      <phonenumber>Mobile phone number</phonenumber>
    </Phone>
  </Contact>
</AddressBook>
```

Object	Position	Type	Values	Comments
AddressBook	Root element	Mandatory	-	Root element of the XML document
Contact	Child element	Mandatory	-	Each contact is an entry
LastName	Child element	At least one of them present	String	Last name of the contact
FirstName	Child element		String	First name of the contact
Phone	Child element	Mandatory	-	Phone number
PhoneNumber	Child element	At least one present	Int	Type="Home" or Type="Work" or Type="Mobile"



XML Phonebook Example:

```
<?xml version="1.0" encoding="UTF-8"?>
<AddressBook>
  <Contact>
    <FirstName>John</FirstName>
    <LastName>Doe</LastName>
    <Ringtone>0</Ringtone>
    <Phone type="Home">
      <phonenumber>1000</phonenumber>
    </Phone>
    <Phone type="Work">
      <phonenumber>1001</phonenumber>
    </Phone>
    <Phone type="Mobile">
      <phonenumber>1002</phonenumber>
    </Phone>
  </Contact>
  <Contact>
    <FirstName>Alice</FirstName>
    <LastName>Beck</LastName>
    <Ringtone>0</Ringtone>
    <Phone type="Home">
      <phonenumber>2000</phonenumber>
    </Phone>
    <Phone type="Work">
      <phonenumber>2001</phonenumber>
    </Phone>
    <Phone type="Mobile">
      <phonenumber>2002</phonenumber>
    </Phone>
  </Contact>
</AddressBook>
```



Global Phonebook via LDAP

1. Access your DP750 base station web UI by entering its IP address in your favorite browser.
2. Enter your admin password (default: admin).
3. Press **Login** to access your settings.
4. Go to **Phonebook > Global Phonebook LDAP Settings** tab.
5. Set **Global Phonebook Type** to **LDAP** (in this case, XML phonebook will not be available).

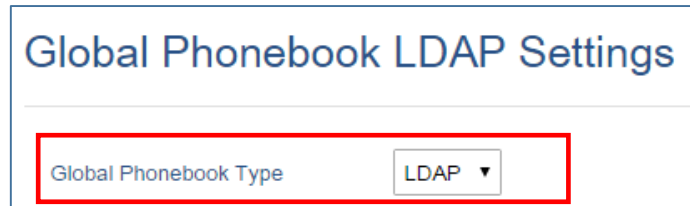

Figure 31: Global Phonebook LDAP Settings

6. Under **LDAP Phonebook Settings**, set your LDAP parameters to connect to your LDAP server. Refer to [Table 11: Phonebook Page Definitions](#) for parameters explanation.
7. Press **Save and Apply** to save your configuration.

Example of configuration:

LDAP protocol: LDAP
Server Address: 192.168.1.100
Port: 389
Base: dc=pbx,dc=com
User Name:
Password:
LDAP Number Filter: (AccountNumber=%)
LDAP Name Filter: (CallerIDName=%)
LDAP Version: Version 3
LDAP Name Attributes: CallerIDName Email Department FirstName LastName
LDAP Number Attributes: AccountNumber MobileNumber HomeNumber Fax
LDAP Display Name: AccountNumber CallerIDName
Max. Hits: 50
Search Timeout: 30
Sort Results: Yes
LDAP Lookup: Incoming Calls / Outgoing Calls (checked)
Lookup Display Name: FirstName LastName



After applying your configuration, your global phonebook will be synchronized with all registered handsets and contacts will be displayed on your DP720 handsets screens.

You can access your Global phonebook by pressing **Contacts** on your DP720 handsets and select **Shared**. Your Global Phonebook contacts will be loaded and displayed on your DP720 screen.

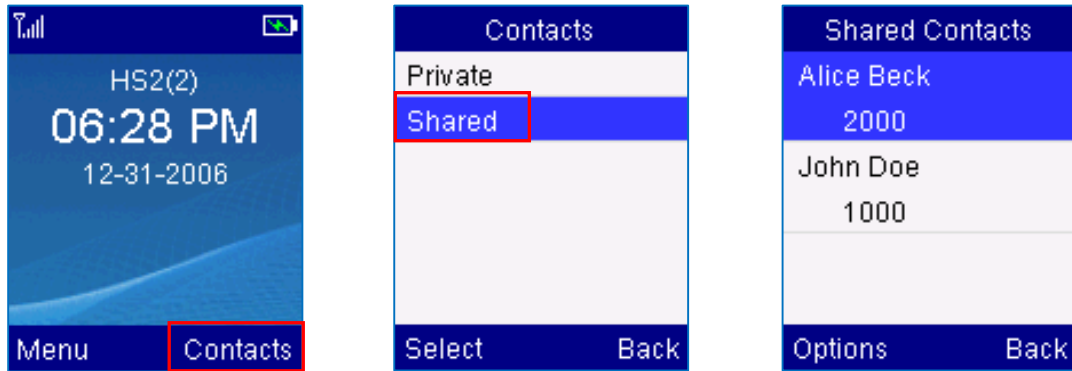

Rebooting from Remote Location

Press the **Reboot** button on the top right corner of the web GUI page to reboot the DP750 remotely. The web browser will then display a reboot message to confirm the reboot by pressing **OK** or avoid by clicking on **Cancel** button. Wait for about 1 minute to log in again.

UPGRADING AND PROVISIONING

The DP750 can be upgraded via TFTP/HTTP/HTTPS by configuring the URL/IP Address for the TFTP/HTTP/HTTPS server and selecting a download method. Configure a valid URL for TFTP or HTTP/HTTPS; the server name can be FQDN or IP address.

Examples of valid URLs:

firmware.grandstream.com

fw.ipvideotalk.com/gs

Firmware Upgrade procedure

Please follow below steps in order to upgrade the firmware version of your DP750 base station:

1. Access your DP750 base station web UI by entering its IP address in your favorite browser.
2. Enter your admin password (default: admin).
3. Press **Login** to access your settings.
4. Go to **Maintenance > Firmware Upgrade** page, enter the IP address or the FQDN for the upgrade server in "**Firmware Server Path**" field and choose to upgrade via TFTP or HTTP/HTTPS.
5. Make sure to configure Firmware **Upgrade and Provisioning** to **Always Check for New Firmware**.
6. Update the change by clicking the "**Save and Apply**" button. Then "**Reboot**" or power cycle the base station to update the new firmware.



Maintenance

Firmware Upgrade

- Provisioning
- Web/SSH Access
- TR-069
- Security Settings
- Date and Time
- Syslog
- Packet Capture
- Factory Reset
- Support

Firmware Upgrade

Base Firmware

Firmware Upgrade Always Check for New Firmware
 Check New Firmware Only When F/W pre/suffix Changes
 Always Skip the Firmware Check

HTTP/HTTPS User Name

HTTP/HTTPS Password

Always send HTTP Basic Authentication Information No Yes

Verify host when using HTTPS No Yes

Upgrade via TFTP HTTP HTTPS

Firmware Server Path

Firmware File Prefix

Firmware File Postfix

Allow DHCP Option 43 and Option 66 to Override Server No Yes

Automatic Upgrade No Yes, check for upgrade every minute(s)
 Yes, check for upgrade every day
 Yes, check for upgrade every week

Hour of the Day(0-23)

Day of the Week (0-6)

Firmware Key

Handset Firmware

Handset firmware

Automatic Upgrade No Yes

Figure 32: Firmware Upgrade Page

Upgrading via Local TFTP/HTTP Servers

For users that would like to use remote upgrading without a local TFTP/HTTP server, Grandstream offers a NAT-friendly HTTP server. This enables users to download the latest software upgrades for their devices via this server. Please refer to the webpage: <http://www.grandstream.com/support/firmware>

Alternatively, users can download a free TFTP or HTTP server and conduct a local firmware upgrade. A free windows version TFTP server is available for download from:

http://www.solarwinds.com/products/freetools/free_tftp_server.aspx
<http://tftpd32.jounin.net/>.



Instructions for local firmware upgrade via TFTP:



1. Unzip the firmware files and put all of them in the root directory of the TFTP server.
2. Connect the PC running the TFTP server and the phone to the same LAN segment.
3. Launch the TFTP server and go to the File menu->Configure->Security to change the TFTP server's default setting from "**Receive Only**" to "**Transmit Only**" for the firmware upgrade.
4. Start the TFTP server and configure the TFTP server in the phone's web configuration interface.
5. Configure the Firmware Server Path to the IP address of the PC.
6. Save and Apply the changes and reboot the base station.

End users can also choose to download a free HTTP server from <http://httpd.apache.org/> or use Microsoft IIS web server.

Upgrading DP720 handset

User could upgrade their handsets either using the LCD menu or via the Web GUI

- **Upgrading the handsets using the LCD menu**

1. On DP720, press "Menu" (left softkey  or the selection key ) to bring up operation menu.
2. Press arrow keys to move the cursor to **Settings** and then press "Select".
3. Navigate to **Firmware Upgrade** and press "Select" (left softkey), the handset will upgrade the firmware available on the base station.

- **Upgrading the handsets automatically using the Web GUI**

1. Access your DP750 base station web UI by entering its IP address in your favorite browser.
2. Enter your admin password (default: admin).
3. Press **Login** to access your settings.
4. Go to **Maintenance > Firmware Upgrade** page, and enable the **Automatic Upgrade** option so the handset will upgrade the firmware automatically once it detects the new firmware.

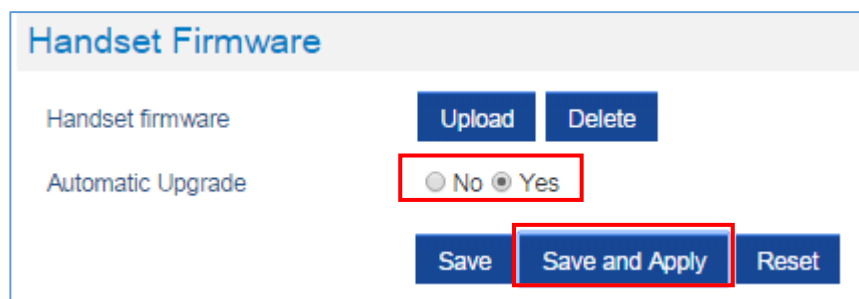

Figure 33: Handset Firmware Upgrade

5. Update the change by clicking the "**Save and Apply**" button.

Notes:

- The DP720 handset detects automatically if the base station is upgraded with a new firmware and display on the LCD a prompt message inviting the user to start the upgrade, more over under the Web GUI of the base station DP750 -> Status -> DECT Status -> Handset Status, appears an **Upgrade All** button once the base detect that several registered handsets are using an old firmware version so the user could upgrade all handsets by pressing Upgrade All button.
- After downloading firmware, DP720 screen will be black and red LED will be blinking showing that firmware upgrade process is ongoing.

Configuration File Download

Grandstream SIP Devices can be configured via the Web Interface as well as via a Configuration File (binary or XML) through TFTP or HTTP/HTTPS. The **Config Server Path** is the TFTP or HTTP/HTTPS server path for the configuration file. It needs to be set to a valid URL, either in FQDN or IP address format. The **Config Server Path** can be the same or different from the **Firmware Server Path**.

A configuration parameter is associated with each particular field in the web configuration page. A parameter consists of a Capital letter P and 2 to 3 (Could be extended to 4 in the future) digit numeric numbers. i.e., P2 is associated with the "New Password" in the Web GUI->Maintenance->Web/SSH Access page->Admin Password. For a detailed parameter list, please refer to the corresponding firmware release configuration template.

When the DP750 boots up or reboots, it will send a request to download a file named "cfgxxxxxxxxxxx" followed by a configuration XML file named "cfgxxxxxxxxxxx.xml", where "xxxxxxxxxxx" is the MAC address of the phone, i.e., "cfg000b820102ab" and "cfg000b820102ab.xml". If the download of "cfgxxxxxxxxxxx.xml" file is not successful, the provision program will download a generic cfg.xml file. The configuration file name should be in lower case letters.

For more details on XML provisioning, please refer to:

http://www.grandstream.com/sites/default/files/Resources/gs_provisioning_guide.pdf



RESTORE FACTORY DEFAULT SETTINGS

Warning:

Restoring the Factory Default Settings will delete all configuration information on the phone. Please backup or print all the settings before you restore to the factory default settings. Grandstream is not responsible for restoring lost parameters and cannot connect your device to your VoIP service provider.

Resetting the DP720 Handset

Please follow the instructions below to reset the DP720 Handset:

1. Press “Menu” (left softkey) to bring up operation menu.
2. Press arrow keys to move the cursor to **Settings** and then press “Select”.
3. Navigate to **System Settings > Factory Reset**, a warning window will pop out to make sure a reset is requested and confirmed;
4. Press “Yes” (left softkey) to confirm and the phone will reboot.
To cancel the Reset, press “No” (right softkey) instead.

Resetting the DP750 Base Station

There are two methods to reset your base station to the default setting:

Via Reset Button

1. Locate the reset hole on the back panel of your DP750.
2. Insert a pin in this hole, and press for about 7 seconds.
3. Take out the pin. The unit will restart automatically with parameters restored to default values.

Note: A quick press on the reset hole will just reboot the unit.

Via Web GUI

1. Access your DP750 base station web UI by entering its IP address in your favorite browser.
2. Enter your admin password (default: admin).
3. Press **Login** to access and navigate to **Maintenance > Factory Reset**.
4. Press Reset button and the unit will prompt a confirmation message, press **OK** to reset the handset, then the unit restart automatically with parameters restored to default values or press **Cancel** to annul the reset.



EXPERIENCING DP750/720

Please visit our website: <http://www.grandstream.com> to receive the most up- to-date updates on firmware releases, additional features, FAQs, documentation and news on new products.

We encourage you to browse our [product related documentation](#), [FAQs](#) and [User and Developer Forum](#) for answers to your general questions. If you have purchased our products through a Grandstream Certified Partner or Reseller, please contact them directly for immediate support.

Our technical support staff is trained and ready to answer all of your questions. Contact a technical support member or [submit a trouble ticket online](#) to receive in-depth support.

Thank you again for purchasing Grandstream DECT IP phone, it will be sure to bring convenience to both your business and personal life.

