

EnGenius®

User Manual

DuraFon USL

Long-Range, Single-Line, Dual-Mode Radio Phone System

(UHF Single-Line, Cordless Phone,
Digital Radio and Analog UHF Two-Way Radio)



EnGenius Customer Service
<http://www.engeniustech.com/>
<http://www.engeniuscanada.com/>

Table of Contents

Safety Instructions.....	4
General Safety Instructions.....	4
Product Safety Instructions.....	4
Battery Safety Instructions	6
Regulatory Information.....	7
Equipment Checklist.....	10
Handset Illustration.....	11
Handset Features	13
Basic Handset Features.....	13
Additional Handset Features	15
Administrator Features (Register to PRO base).....	17
Charger Illustration	21
Charger Features	24
Getting Started.....	26
Handset and Charger Installation	28
Basic Operations.....	26
Operation Modes.....	30
A. Base Operation Modes	30
B. Handset Operation Modes	30
Menu Tree (Register to PRO base only).....	31
Making a Telephone Call.....	31
Making an 2-Way/ Intercom Call	32
A. Handset to Handset Calls	32
Making a Broadcast via 900MHz.....	33
A. Handset to Handset Calls	33
Making a Broadcast via UHF	34
A. Handset to UHF walkie-talkie	34
Scanning via UHF.....	34
Monitoring via UHF.....	35
Redial	35
Receiving a Telephone Call	35
Receiving an Intercom Call.....	36
Ending a Call.....	36
Adjusting Voice Volume in Phone mode	37
Adjusting Volume in Walkie-Talkie	37
Placing a Call On Hold	37
Mute.....	38

Do Not Disturb (Silent Ring).....	38
Key Guard.....	38
To View Missed Call(s)	38
To Call back from Call Log	39
Battery Recharge and Replacement	39
Programming Mode in Walkie-Talkie	40
Advanced Operations.....	42
Handset Registration (Register to PRO base only).....	42
Advanced Registration (Register to PRO base only)	43
Handset Group Subscription.....	44
Call Transfer (Register to PRO base only)	44
3-Way Conferencing (Register to PRO base only)....	Error! Bookmark not defined.
Base Select (Register to PRO base only)	45
Call Waiting (Register to PRO base only) ..	Error! Bookmark not defined.
Auto Attendant (AA) (Register to PRO base only) ...	Error! Bookmark not defined.
AA Configuration by Administrator (Register to PRO base only).....	Error! Bookmark not defined.
Change AA Parameters (Register to PRO base only)	Error! Bookmark not defined.
Line Dedication (Register to PRO base only)	46
Line Selection (Register to PRO base only)	46
Change System and Line Settings by Administrator (Register to PRO base only)	47
Phonebook Operations (Register to PRO base only)	48
Programmable PBX Options (Register to PRO base only).....	52
Broadcast through PBX (Register to PRO base only)	Error! Bookmark not defined.
Repeater Operation	53
UHF Frequencies and Codes.....	55
Menu Operations (Register to PRO base only)	58
Technical Specifications	64
Index.....	66
FCC Part 68 Statement	67
Industry Canada statement:.....	69

Safety Instructions

Caution: *Your wireless telephone gives you freedom and flexibility to stay in touch while you move around. However, when using your phone equipment, safety instructions should be followed to avoid the risks of fire, electric shock, injury to person, and damage to property.*

General Safety Instructions

1. When using your wireless phone, ensure your safety and the safety of others:
 - a. Always watch where you are walking and standing.
 - b. Don't let a phone call distract you from working safely.
 - c. If power goes out, it won't work. Recommend backup power.
2. In an emergency:
 - a. If an emergency occurs, dial the emergency phone number. Remember: if you are in an area where your phone does not have a clear signal from the base, it is highly probable that the call may not go through. Locate the nearest landline telephone or other communications device to call for help.
 - b. Emergency calls may not automatically provide emergency personnel with your name, phone number or location.
3. Notice to Hearing Aid Users: This phone system is compatible with inductively coupled hearing aids.
4. Notice to Cardiac Pacemaker Users: Preliminary studies done by the US FDA and others have shown that, although interference to the implanted cardiac pacemaker may occur when operating very closely, wireless telephones "do not seem to pose a significant problem for pacemaker wearers." However, until more is known, FDA suggests that people with pacemakers may want to take precautions when using or carrying a wireless telephone to ensure that there is ample distance between the telephone and the pacemaker. Do not carry the handset in a breast pocket. If you have any reason to suspect that interference is taking place, turn off your handset immediately.

Product Safety Instructions

1. Read and understand all instructions.
2. Follow all warnings and instructions including those marked on the product.
3. Changes or modifications to this product not expressly approved by the manufacturer will void the warranty and the FCC authorization to operate the equipment. Use only manufacturer provided accessories.

4. Do not use the telephone near water. Never spill liquid of any kind on this product.
5. Unplug the product from the wall telephone jack and power outlet before cleaning. Do not use liquid or aerosol cleaners. Use damp cloth for cleaning.
6. Do not place this product on an unstable cart, stand, or table. The product may fall and cause personal injury or damage to the product or other property.
7. Power Outage: In the event of a power outage, your handset charger will not recharge the handset battery, and the base station will not allow you to make an outgoing call or take an incoming call. Both the charger and the base station require electricity for operation. You should have a telephone that does not require electricity available for use during power outage, or have a temporary backup power supply.
8. Slots or openings in the product's housing are provided for ventilation. These openings must not be blocked or covered. Placing the product on a bed, carpeting, or other similar surface may block these openings and should be avoided. This product should never be placed near or over a radiator or heat register, or in a built-in installation unless proper ventilation is provided.
9. Never push objects of any kind into this product through housing slots/openings as they may damage the product, touch dangerous voltage points or short out parts that could result in fire, electric shock, or injury.
10. This product should be operated only from the type of power source indicated on the marking label. If you are not sure of the type of power supply to your home, consult your dealer or local power company.
11. Do not overload wall power outlets and extension cords as this may result in fire or electric shock.
12. To avoid electric shock or burn, do not disassemble this product. Send this product to an authorized service center when service or repair work is required. Call Customer Service for locations near you. Opening or removing covers may expose you to dangerous voltages, electrical currents or other risks. Incorrect reassembling of the product may cause electric shock when the product is subsequently used.
13. Avoid using the product during a storm. There may be a risk of electric shock from lightning.
14. Do not place the product where persons can step, trip, or fall on it.
15. Do not place conductive objects over or near the antenna.
16. Do not use the product to report a gas leak while in the vicinity of the leak.
17. Do not install the base station or the handset charger near microwave ovens, radios, TV sets, speakers, or other electrical equipment. These appliances may cause interference to the product or experience interference from the product.
18. Unplug the base station or the charger adaptor from the power outlet and refer to an authorized service center under the following conditions:

- a. If liquid has been spilled into the product.
- b. When the power supply cord or plug is damaged or frayed.
- c. If the product has been exposed to rain or water.
- d. If the product does not operate normally by following the operating instructions.
- e. If the product has been dropped or housing has been damaged.
- f. If the product shows a distinct change in performance.

Battery Safety Instructions

1. Use only manufacturer approved Li-ion rechargeable batteries and charger. Do not use other types of rechargeable batteries or non-rechargeable batteries. The batteries could short-circuit, and the battery enclosure may be damaged causing a hazardous condition.
2. Follow the charging instruction in this manual and instruction labels and markings in the handset and charger compartments.
3. Battery must be recycled or disposed of properly. Do not dispose the battery in a fire. The cells may explode.
4. Do not dispose of the battery in municipal waste. Check with local codes for disposal instructions.
5. Exercise care in handling the batteries in order not to short-circuit the battery with conductive materials such as rings, bracelets, keys, pocketknife, and coins. The battery or conductive material may overheat and cause burn or fire.
6. Do not expose batteries to rain or water.
7. Do not open or mutilate the battery. Released electrolyte is corrosive and may cause injury to eyes or skin. The electrolyte may be toxic if swallowed.
8. During charging, the battery heats up. This is normal and is not dangerous.

Regulatory Information

SPR-922U1

FCC ID: A8J-922PSLBU(Base), A8J-SPR922U1(Handset)

IC: 10103A-922PSLBU(Base), 10103A-SPR922U1(Handset)

This device complies with Part 15 of the FCC Rules. Operation is subject to the following two conditions:

- 1) this device may not cause harmful interference, and
- 2) this device must accept any interference received, including interference that may cause undesired operation.

Privacy of communications may not be ensured when using this phone.

Base Station

Federal Communication Commission Interference Statement

This equipment has been tested and found to comply with the limits for a Class B digital device, pursuant to Part 15 of the FCC Rules. These limits are designed to provide reasonable protection against harmful interference in a residential installation. This equipment generates uses and can radiate radio frequency energy and, if not installed and used in accordance with the instructions, may cause harmful interference to radio communications. However, there is no guarantee that interference will not occur in a particular installation. If this equipment does cause harmful interference to radio or television reception, which can be determined by turning the equipment off and on, the user is encouraged to try to correct the interference by one of the following measures:

- Reorient or relocate the receiving antenna.
- Increase the separation between the equipment and receiver.
- Connect the equipment into an outlet on a circuit different from that to which the receiver is connected.
- Consult the dealer or an experienced radio/TV technician for help.

FCC Caution: Any changes or modifications not expressly approved by the party responsible for compliance could void the user's authority to operate this equipment.

This device complies with Part 15 of the FCC Rules. Operation is subject to the following two conditions: (1) This device may not cause harmful interference, and (2) this device must accept any interference received, including interference that may cause undesired operation.

IMPORTANT NOTE:

FCC Radiation Exposure Statement:

This equipment complies with FCC radiation exposure limits set forth for an uncontrolled environment. This equipment should be installed and operated with minimum distance 20cm between the radiator & your body.

This transmitter must not be co-located or operating in conjunction with any other antenna or transmitter.

Industry Canada statement:

This device complies with RSS-247 of the Industry Canada Rules. Operation is subject to the following two conditions:

(1) This device may not cause harmful interference, and (2) this device must accept any interference received, including interference that may cause undesired operation.

IMPORTANT NOTE:

Radiation Exposure Statement:

This equipment complies with IC radiation exposure limits set forth for an uncontrolled environment. This equipment should be installed and operated with minimum distance 20cm between the radiator & your body.

This device has been designed to operate with an antenna having a maximum gain of 2 dBi. Antenna having a higher gain is strictly prohibited per regulations of Industry Canada. The required antenna impedance is 50 ohms.

Portable Handset

Federal Communication Commission Interference Statement

This equipment has been tested and found to comply with the limits for a Class B digital device, pursuant to Part 15 of the FCC Rules. These limits are designed to provide reasonable protection against harmful interference in a residential installation. This equipment generates, uses and can radiate radio frequency energy and, if not installed and used in accordance with the instructions, may cause harmful interference to radio communications. However, there is no guarantee that interference will not occur in a particular installation. If this equipment does cause harmful interference to radio or television reception, which can be determined by turning the equipment off and on, the user is encouraged to try to correct the interference by one of the following measures:

- Reorient or relocate the receiving antenna.
- Increase the separation between the equipment and receiver.
- Connect the equipment into an outlet on a circuit different from that to which the receiver is connected.
- Consult the dealer or an experienced radio/TV technician for help.

FCC Caution: Any changes or modifications not expressly approved by the party responsible for compliance could void the user's authority to operate this equipment.

This device complies with Part 15 of the FCC Rules. Operation is subject to the following two conditions: (1) This device may not cause harmful interference, and (2) this device must accept any interference received, including interference that may cause undesired operation.

IMPORTANT NOTE:

Radiation Exposure Statement:

This equipment complies with FCC radiation exposure limits set forth for an uncontrolled environment. It complies with the occupational/controlled environment exposure limits. End users must follow the specific operating instructions for satisfying RF exposure compliance. To maintain compliance with FCC RF exposure compliance requirements, please follow operation instruction as documented in this manual.

This transmitter must not be co-located or operating in conjunction with any other antenna or transmitter.

Industry Canada statement:

This device complies with RSS-247 of the Industry Canada Rules. Operation is subject to the following two conditions: (1) This device may not cause harmful interference, and (2) this device must accept any interference received, including interference that may cause undesired operation.

IMPORTANT NOTE:

Radiation Exposure Statement:

This equipment complies with IC radiation exposure limits set forth for an uncontrolled environment. End users must follow the specific operating instructions for satisfying RF exposure compliance. To maintain compliance with IC RF exposure compliance requirements, please follow operation instruction as documented in this manual.

This device has been designed to operate with an antenna having a maximum gain of 2 dBi (900MHz). Antenna having a higher gain is strictly prohibited per regulations of Industry Canada. The required antenna impedance is 50 ohms.

Equipment Checklist

In DuraFon USL, it includes one base (DuraFon PSL-BU) and one handset package(DuraFon PRO UHF HC) as the following :

- a. Base Station x 1 Handset x 1
- b. Base Antenna x 1
- c. Base AC/DC Adaptor x 1
- d. Handset x 1
- e. Handset Antenna x 1
- f. 2300mA Li-ion Battery x 1
- g. Charger x 1
- h. Charger AC/DC Adaptor x 1
- i. Telephone Cord x 1
- j. Audio-in Cable x 1
- k. Clip Fastener x 1
- l. Belt Clip x 1
- m. Quick Guide and Warranty Card

Handset Illustration

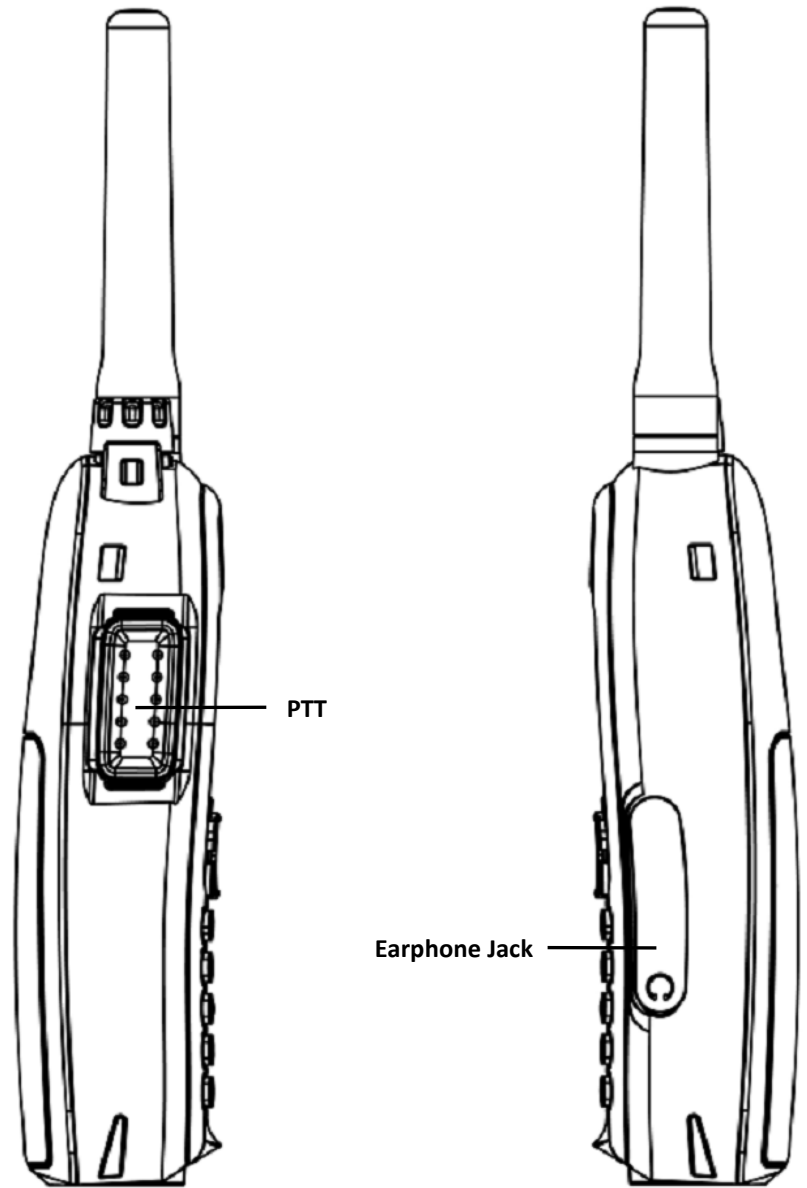
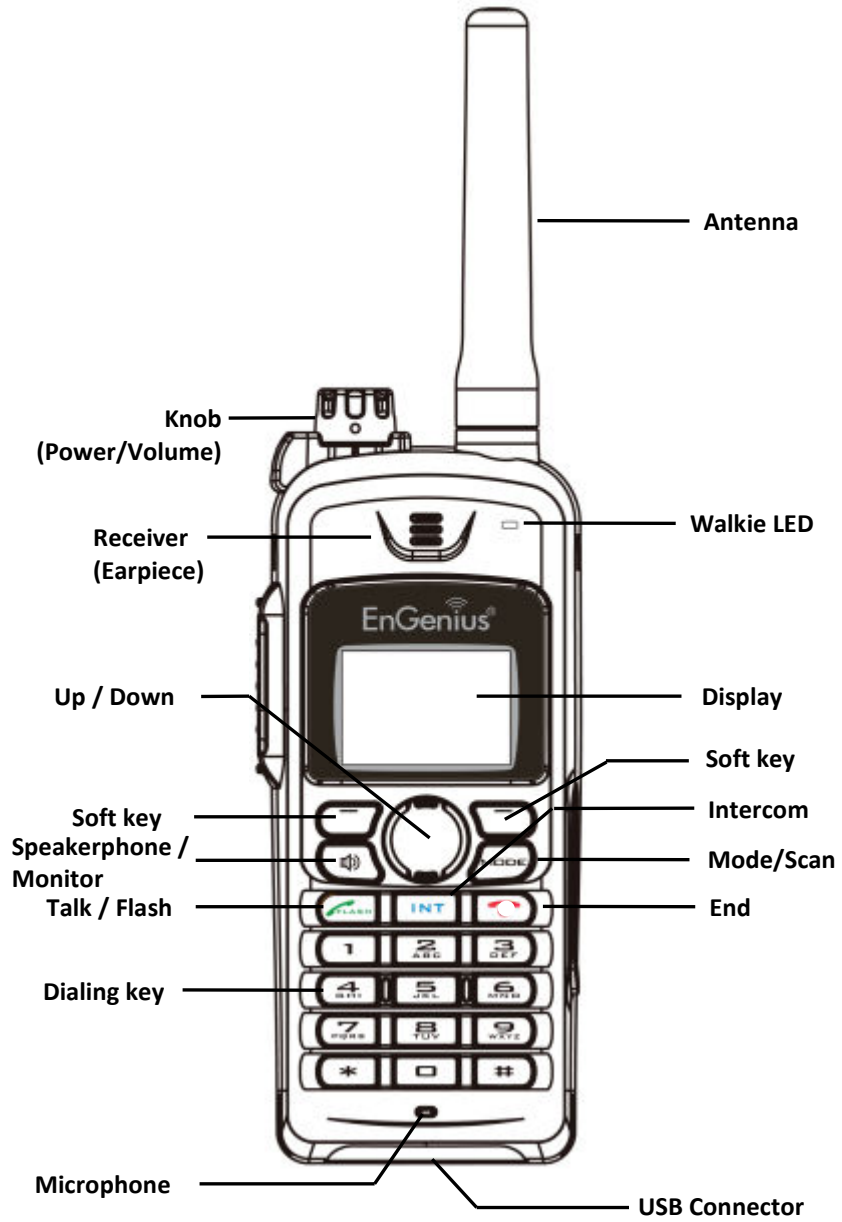

Handset Features

Basic Handset Features

1. 4-line LCD (Liquid Crystal Display)

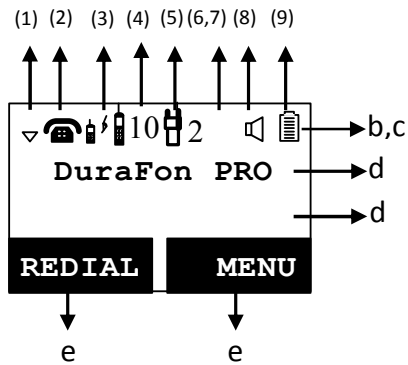

- a. The LCD display has LED (Light Emitting Diode) for backlighting.
- b. The 1st line of LCD consists of icons.
- c. Icons explanation from left to right
 - (1) **RSSI** (Receive Signal Strength Indicator)
During a call, the number of bars is proportional to the radio signal strength received.
 - (2) **Call in-progress** (ON/OFF-Hook)
Indicates if phone line mode is active
 - (3) **Intercom in-progress**
Indicates if Intercom mode is active
 - (4) **Handset ID**
Displays a handset icon and a 2-digit Handset ID
 - (5) **Channel number in Walkie**
Indicates the Channel (1~5) selected
 - (6) **Two-Digit Address Index**
Shows address index when viewing contents of the call logs.
 - (7) **Line Indicator**
Indicates the number of the line being accessed by the handset.
 - (8) **Speaker phone**
Indicates if speaker phone is active
 - (9) **Battery Strength**
 - Number of bars is proportional to the amount of battery time remaining.
 - Indicates charging when in charger cradle.
- d. The 2nd and 3rd lines of the LCD, maximum 14 characters each, display status, message, menu selections, or user-editable alphanumeric

- characters.
- e The last line displays the left and right soft keys.

2. Ringer

- a. Rings to an incoming call.
- b. Distinctive alert sounds indicating various events:
 - (1) Single Beep: successful key entry
 - (2) Double beep: failed operation or invalid key entry, also indicates power on/off
 - (3) Periodic 1-Long-2-Short Beep (every 1 minute): low battery warning
 - (4) Periodic Long Series of Beeps (repeat every 30 seconds): indicates a call is on-hold

3. TALK/FLASH

- a. Places or answers a telephone or intercom call
- b. Sends a Flash signal to phone line to retrieve a dial tone after the call ends, or to perform the call waiting feature provided by local phone companies during a call.
- c. Press and hold the key for one second to enable/disable speakerphone.

4. SPEAKERPHONE

- a Press the key to enable/disable the speakerphone during incoming, outgoing or intercom call.
- b. During IDLE mode, press and hold the key to activate/deactivate Monitoring

5. 2-WAY INTERCOM

- a. Places an intercom call to another handset ID or a group ID (**group paging**).
- b. Intercom calls are digital, full duplex, and are conducted without the assistance from the base.

6. PTT

- a. Activate the half duplex broadcasting via UHF band or 900MHz band
- b. Press the Mode key repeatedly to set the desired channel (1~5) in advance.
Re. PTT operation should be limited to 50% duty cycle.

7. Left/Right Soft Keys /

Make menu selection.

8. Up / Down Scrolling Keys

- a. Scroll through records and menu selections.
- b. Adjust receiver voice volume when in Talk mode.

9. END Key ()
 - a. Ends a call.
 - b. Leaves current menu operation, up one level.

10. MODE Key ()
 - a. Select channel of UHF 2-way radio
 - b. Setting channel/Frequency/ Code/Microphone gain/VOX in programming mode
 - c. During IDLE mode, press and hold the key to activate/deactivate scanning.

Note, to access programming mode for 2-way radio, press and hold this MODE button while turning the radio on

11. Walkie LED
 - a. The Walkie LED on the front of handset is red light when transmitting.
 - b. Static green is to indicate receiving UHF signal
 - c. Standby LED blinks in green

Additional Handset Features

2. Multiple handsets registration (Register to PRO base)
 - a. Up to 90 handsets.
 - b. ID 10 and 11 are the first two ID's assigned by the base and are designated "administrators" who can change base settings such as greeting message and other base administrative functions.
Note: Unless necessary, it is better not to assign ID 10 and 11 to DuraWalkie handsets.
 - c. ID 01-07: Group IDs. Handsets can "subscribe" from the handset menu to group(s) and be paged when a landline caller or an intercom caller enters a Group ID.

3. Ringer / Vibrator
 - a. Six-level ringer volume selections (high/ medium/low/ vibrate/ vibrate-then-ring/ off)
 - b. Four ringer type selections

4. Caller ID

Displays incoming call phone number and name on the LCD (needs Caller ID service from local telephone company)

5. Call waiting with caller ID

Displays 2nd incoming call information on the same phone line when 1st call is in progress (needs Call Waiting with Caller ID service from local telephone company)

6. Name tagging with caller ID

Match the caller ID with the phone book entries; once matched, the LCD screen will display the name or nickname instead of pure caller ID info (needs Call Waiting with Caller ID service from local telephone company)

7. DND (Do Not Disturb, i.e., Silent Ring)

8. Three Call Logs
 - a. Called Log: Stores 10 phone numbers (up to 28 digits each) dialed most recently. Can perform last-number redial on all 10 numbers.
 - b. Received Call Log: 10 entries (14-digit phone number, 14-character names, and time stamp), needs Caller ID service from local telephone company.
 - c. Missed Call Log: 10 entries (14-digit phone number, 14-character names, and time stamp), needs Caller ID service from local telephone company.
 - d. Phone numbers and names can be saved into phonebook while in display.

9. Key-guard

10. Dialing Prefix

Up to 14 digits, including pause(s), one access code can be pre-programmed to be added automatically in front of the dialed number when dialing from call logs, phonebook, and dial-and-send dialing.

11. Call Hold
 - a. Places call on hold
 - b. Battery Hot Swap: Change battery while call is on hold.

12. Mute

13. Phonebook
 - a. 90 entries, each stores a phone number or handset ID (up to 28-digit) and name (up to 14-character)
 - b. Alphabetically sorted display and search
 - c. Dial from display
 - d. During the stand-by mode, you can enter the phone book by pressing  scrolling key
 - e. Phone book transfer via air
 - i. Transfer specific phonebook to one handset or all registered handsets
 - ii. Transfer all phonebooks to one handset or all registered handsets

14. Key tone
 - a. Three-level key-tone volume selections (high/low/off)
 - b. Four key-tone type selections

15. Call timers
Display call time duration for current call during and immediately after the call
 16. Call Transfer (Register to PRO base)
 - a. Direct Transfer: transfer a telephone call to another handset without announcement.
 17. Programmable PBX Options:
 - a. Allow user to pre-program the most frequently used PBX feature along with its feature code into DuraFon which is adjunct to the PBX system.
 - b. Up to 9 entries can be saved.
 - c. Once the feature and feature codes being programmed, you can quick perform those functions during the call by pressing **OPTION** soft key.
 18. Base Selection (Register to PRO base)
When enable from the handset menu, a handset user can manually select the base which is the nearest one with user before making an outgoing call.
 19. Repeater Operation (Register to PRO base)
In order to get better range performance for handset to handset calls(intercom and broadcast), install a repeater and make the calls via repeater is able to extend the range of handset to handset calls.
3. Call Transfer to PBX Extension(For DuraFon PRO only)
 - a. When the DuraFon PRO is installed behind a PBX system, you can pre-program the feature code of call transfer function.
 - b. Need to adjust the Flash time to match your PBX setting.
 Re: If loosing administrator handsets (handset 10 and 11), all settings must be reset (reset the base and re-register all handsets).

Administrator Features (Register to PRO base)

Handsets 10 and 11 are designated administrators. Both have the same authority to perform base station administrative functions from their handset menu selections. No password is required.

1. Supports both DTMF and Pulse dialing(For DuraFon PRO only)
 - a. From an administrator handset (Handset 10 or 11), press **MENU-9-1** enter base ID(00-07)-**1** to select Tone or Pulse dialing mode.
 - b. Default is Tone dialing.
2. Administrator programmable Flash key timing(For DuraFon PRO only)
 - a. From an administrator handset (Handset 10 or 11), press **MENU-9-1** enter base ID(00-07)-**2** to select flash key timing
 - b. 9-level (100 ms - 900 ms) timing selections, default= **300 ms**.
 - c. The default value (**300 ms**) works in most areas. Changing this setting may result in Flash function not working. Change only when you are certain the new value will work.

Base Illustration

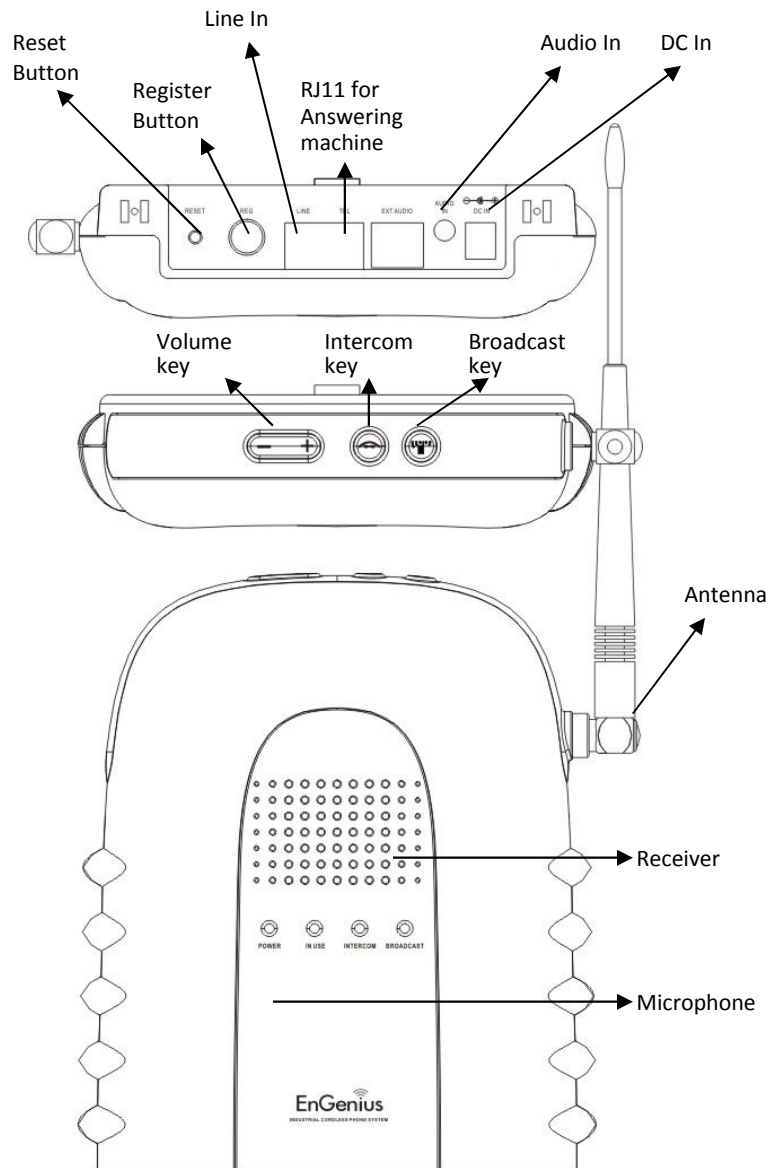

Base Features

Basic Base Station Features

1. Antenna
 - a. The antenna port has a **reverse thread connector**; to remove antenna or cable, turn clockwise; to install, turn counterclockwise. Improper installation may damage the connector
 - b. When using an outdoor antenna, locate the antenna (not the base station itself) as high as possible for a clear transmission path.
2. LED
 - a. Power: it indicates base station has power.
 - b. In-Use: it indicates an active telephone line.
 - c. Intercom: it indicates "Intercom" taking place.
 - d. Broadcast: it indicates "Broadcast" taking place.
3. Reset Button
 - a. Restores base station to factory settings
 - b. Reset button is indented to prevent accidental system reset.
 - c. All handsets (including administrator) and additional base(s) need to be re-registered after a base station reset.
4. Registration Key (REG)
Enters registration mode along with handset, assigns handset ID (10-90).
5. Line
Standard RJ-11C/CA-11A connector to plug in the telephone line
6. Telephone:
Another RJ-11C to plug in the optional answering machine
7. Audio-in Jack (3.5mm)
8. DC In: to plug in the power adaptor
9. Voice Volume

Base Features



Basic Base Station Features

1. Antenna
 - a. The antenna port has a **reverse thread connector**; to remove antenna or cable, turn clockwise; to install, turn counterclockwise. Improper installation may damage the connector
 - b. When using an outdoor antenna, locate the antenna (not the base station itself) as high as possible for a clear transmission path.
2. LED
 - a. Power: it indicates base station has power.
 - b. In-Use: it indicates an active telephone line.
 - c. Intercom: it indicates "Intercom" taking place.
 - d. Broadcast: it indicates "Broadcast" taking place.
3. Reset Button
 - a. Restores base station to factory settings
 - b. Reset button is indented to prevent accidental system reset.
 - c. All handsets (including administrator) and additional base(s) need to be re-registered after a base station reset.
4. Registration Key (REG)
Enters registration mode along with handset, assigns handset ID (10-90).
5. Line
Standard RJ-11C/CA-11A connector to plug in the telephone line
6. Telephone:
Another RJ-11C to plug in the optional answering machine
7. Audio-in Jack (3.5mm)
8. DC In: to plug in the power adaptor
9. Voice Volume

Additional Base Station Features



Broadcast

A. Broadcasting from Base to Handset

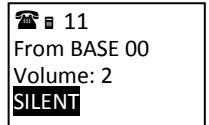
1. Broadcast to all handsets
 - a. Press  key on the base station to intercom all registered handsets.
 - b. Hear bi-bi-beep while the initiating handset broadcast all handsets within communication coverage.
 - c. The Broadcast LED will light up
 - d. Press the  key again and return to IDLE mode



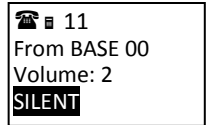

B. Broadcasting from Handset to Base

1. Broadcast to all Bases (DuraFon PSL-BU)
 - a. Press and hold the  key on the handset to broadcast all handsets and bases.
 - b. Start to speak the message to be broadcasted once you hear the "beep" sound; the speakerphone of the base will be opened up.
 - c. The Broadcast LED on the bases will light up
 - d. Press the  key again and return to IDLE mode



Intercom Call

A. Intercom/2-Way from Base to Handset

1. Press  key on the base station to intercom all registered handsets. The first handset to answer will establish a voice link with the base.
2. The INTERCOM LED will flash until a handset responds.
3. The base unit will page for 15 seconds, then terminate the page if no handset responds.
4. Before a handset answers, the INTERCOM can be cancelled from the base by pressing  again. However, once a handset answers, only the answering handset can end the call.

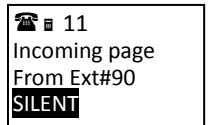

Notes:

1. Due to for comply with existing DuraFon-HC, the display does not match the behavior. For example, the intercom call from base to handset, it displays "from Ext #90" instead of "from Base xx".
2. No support line detection feature in DuraFon PSL-BU base. Even you set "Line Det" from an administrator handset (Handset 10 or 11) via pressing **MENU-9-1**—enter base ID(00-07)-**3** to enable Line Det.
3. In DuraFon PSL-BU base, no support "Auto Attendant".
4. In DuraFon PSL-BU base, no support "3-way Conference".
5. In DuraFon PSL-BU base, no support "Announced call transfer"
6. In DuraFon PSL-BU base, no support " call waiting" from other telephone lines, due to it is only single line.
7. In DuraFon PSL-BU base, no support "Broadcast through PBX"

Administrator Features

Handsets 10 and 11 are designated administrators. Both have the same authority to perform base station administrative functions from their handset menu selections. No password is required.

1. Supports both DTMF and Pulse dialing(For DuraFon PRO only)
 - a. From an administrator handset (Handset 10 or 11), press **MENU-9-1**—enter base ID(00-07)-**1** to select Tone or Pulse dialing mode.
 - b. Default is Tone dialing.
2. Administrator programmable Flash key timing(For DuraFon PRO only)
 - a. From an administrator handset (Handset 10 or 11), press **MENU-9-1-2** to select flash key timing
 - b. 9-level (100 ms - 900 ms) timing selections, default= **600 ms**.
 - c. The default value (**600 ms**) works in most areas. Changing this setting may result in Flash function not working. Change only when you are certain the new value will work.
3. Call Transfer to PBX Extension(For DuraFon PRO only)
 - a. When the DuraFon PRO is installed behind a PBX system, you can pre-program the feature code of call transfer function.
 - b. Need to adjust the Flash time to match your PBX setting.

Re: If loosing administrator handsets (handset 10 and 11), all settings must be reset (reset the base and re-register all handsets).

Charger Illustration

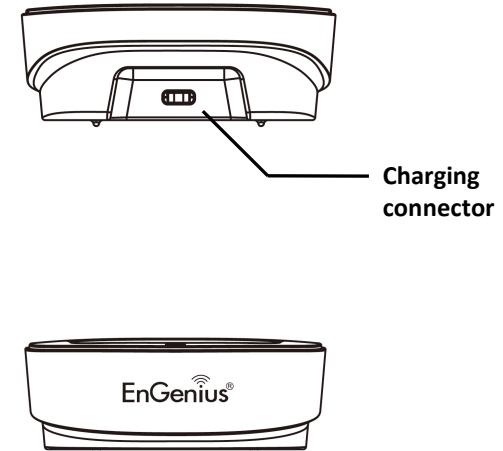
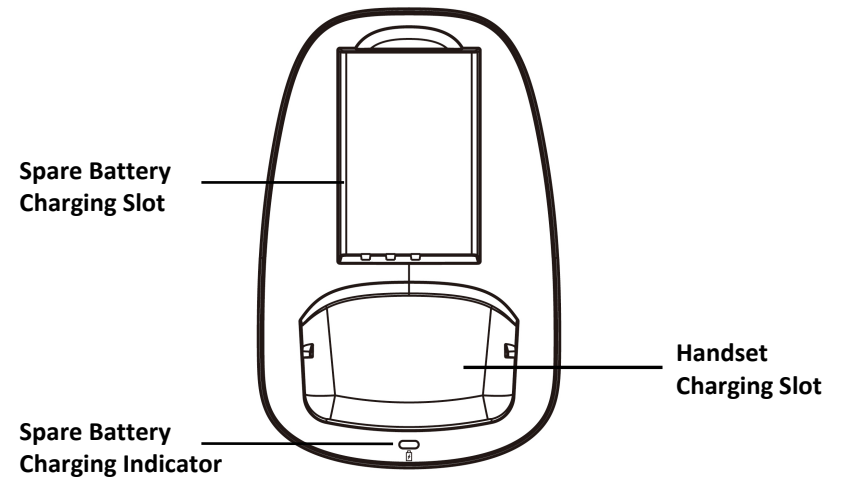

Charger Features

1. DC In
Connects to Charger AC Adaptor.
2. Handset Charging Slot
 - a. Charge handset battery when handset is placed in cradle.
 - b. Refer to the handset LCD for charging status
 - (1) Charging: battery status bar is running and the LCD screen showed: Charging
 - (2) Fully Charged: battery status bar stands still and the LCD screen would display "Fully Charged"
 - (3) Charge Fail: Should there be any error occurred during charging mode, the LCD screen would display "Charge Fail"
3. Spare Battery Charging Slot
 - a. Charge spare battery when battery is placed in slot.
 - b. LED as the spare battery charging indicator
 - (1) Charging: LED is green light
 - (2) Full charged or slot is empty: LED is off
4. It is impossible to overcharge the battery using this charger.

Notes:

1. Fully charge battery packs before first use.
2. Both handset and spare batteries can be charged at the same time.

Getting Started

Basic Operations

Base Station Installation

For best performance, maintain a distance of at least 1 meter (about 3 feet) between the base station and other electronic devices (e.g., TV, computer, stereo, fax machine, answer machine, cordless phone, etc.)

1. Install base station antenna.
The base station's antenna port has a **reverse-thread connector**; to install antenna or cable, turn counter-clockwise; to remove, turn clockwise. Improper installation may damage the connector.
2. Plug the transformer end of the base station AC/DC adaptor into a standard AC electrical power outlet, plug the other end into the "DC In" jack on the back of the base station.
 - a. The base adaptor's DC plug is larger in dimension than the charger's DC plug. The charger adaptor's DC plug will not fit into the base's DC In jack.
 - b. The base station's power supply (DC Adaptor) and telephone line should be plugged into a surge protector with phone line protection.
3. Plug phone cord into the "LINE" Jack
4. A standard telephone or answering machine can be plugged into the adjacent receptacle on the bottom of the base station marked TEL
5. To use the Music/Message-On-Hold feature: Connect one end of a standard audio cable into a radio or audio player, and plug the other (3.5 mm) end into the MOH jack on back of the base.

Multi-base setups:

EnGenius DuraFon PRO has the capability to expand the coverage or capacity.

Re: For best performance, maintain a distance of at least 10 meters (about 30 feet) between any two base stations.

- Expanding coverage
Parallel connects the telephone lines in each base as below schematic(i.e. for 4-line base, up to 8 bases), the use coverage will be several times increased.
Note: Telephone calls cannot be handed off between base units.

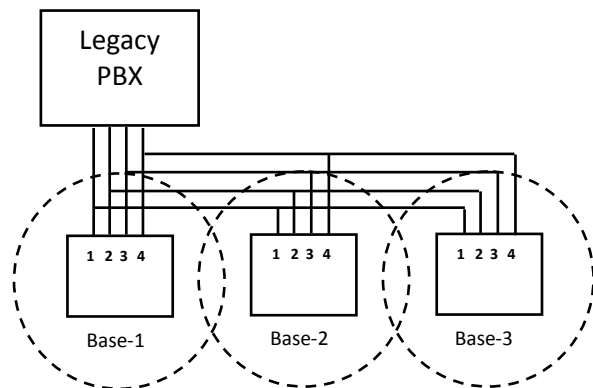

Re : when a call is coming in from L1, all handsets can pick up the call, as long as the handsets are in the coverage of base1~3.

1. Handset Registration.

- a. Press **REG** button on Base 00(default), four LEDs will light up in setting mode
- b. Handset operation: Press **MENU**→**6**→**1**. (It will complete the registration process)
- c. Repeat, as needed, to add handsets

Note: Additional handsets should be added to the system before adding additional base units.

2. Establishing additional Base Units:

- a. Press **REG** button on new Base.
- b. Use Handset 10 or 11 to Add base :
Press **MENU**→**8**→**1**
- c. Enter 01~07 (base ID)
- d. Repeat, as needed, to add base units

☎ 10
Select Mode:
1. Add Base

☎ 10
Added Base
Number : **
CANCEL

Notes:

1. Only Handset 10, 11 can assign Base ID.
2. Base 00 is a primary base. All handsets must register only on Base 00.

● Expanding capacity

User capacity can be increased by adding additional base units. Up to 8 base units can be supported.

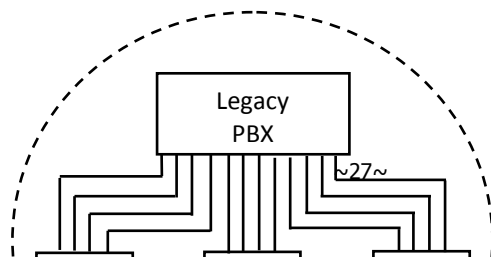

Re : Handsets can answer calls from any port or line, unless port is dedicated to a specific handset or group.

1. Handset Registration.

- a. Press **REG** button on Base 00(default), four LEDs will light up in setting mode
- b. Handset operation: Press **MENU**→**6**→**1**. (It will complete the registration process)
- c. Repeat, as needed, to add handsets

2. Establishing additional Base Units:

- a. Press **REG** button on new Base.
- b. Use Handset 10 or 11 to Add base :
Press **MENU**→**8**→**1**
Enter 01~07 (base ID)
- c. Repeat, as needed, to add base units

☎ 10
Select Mode:
1. Add Base

☎ 10
Added Base
Number : **
CANCEL

Notes:

1. Only Handset 10, 11 can assign Base ID.
2. Base 00 is a primary base. All handset must register only on Base 00.
3. To avoid interference, the interval between any two bases should be at least 10 meters.

Handset and Charger Installation

1. Plug the transformer end of the Charger AC/DC adaptor into a standard AC electric power outlet, plug the other end into the “DC In” jack on the back of the Charger.
2. Install battery pack onto the handset.

3. Install handset antenna.
4. Place handset onto the charger front slot.
5. Fully charge the battery for three hours before use.
6. The phone system is now ready to perform basic functions such as making and receiving phone calls and intercom calls. No base station or handset programming is needed for basic operations.

Note:

1. Handset(s) packaged along with a Base Station are pre-registered at the factory. If you have a new handset, you will need to register the handset with the base station in order to be recognized as a member handset by the base(s) and by other handsets. See Handset Registration.
2. Fully charge battery packs before the first usage.

Basic Operations

Operation Modes

Both the base station and handset have levels of operation at which time only certain procedures of functions can be performed.

A. Base Operation Modes

1. **IDLE mode**- this is the default mode. The intercom, broadcast, and volume keys are active in IDLE mode.
2. **TALK mode**- the base operates in this mode during phone call, intercom, and broadcast operation. The "In Use", "Intercom", and "Broadcast" LED will light up respectively.
3. **REGISTRATION mode**- the base enters this mode by pressing the REG button for three seconds. There are no active base unit keys once this mode has been entered. Four LEDs will be lighted up in Registration mode.

B. Handset Operation Modes

1. **IDLE mode**- this is the default mode.
 - a. If there is no on-going activity, the handset automatically goes into SLEEP/IDLE mode to save battery power.
 - b. Turn the On-Off/Volume knob clockwise. You will hear a beep-beep tone and see LCD and backlight to indicate it is ON.
To turn the handset off, the On-Off/Volume knob counterclockwise.
 - c. The idle screen display (custom name) can be edited.
 - d. The 2-digit number represents the handset ID
2. **Menu mode**
 - a. Press the Right soft function key to activate MENU mode.
 - b. In MENU mode, the handset settings and information contained in memory can be changed.
 - c. The functions available through the MENU selection are covered in greater detail from page 38.
 - d. The MENU structure display as below:

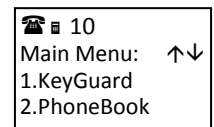
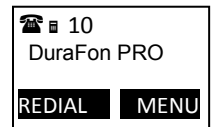



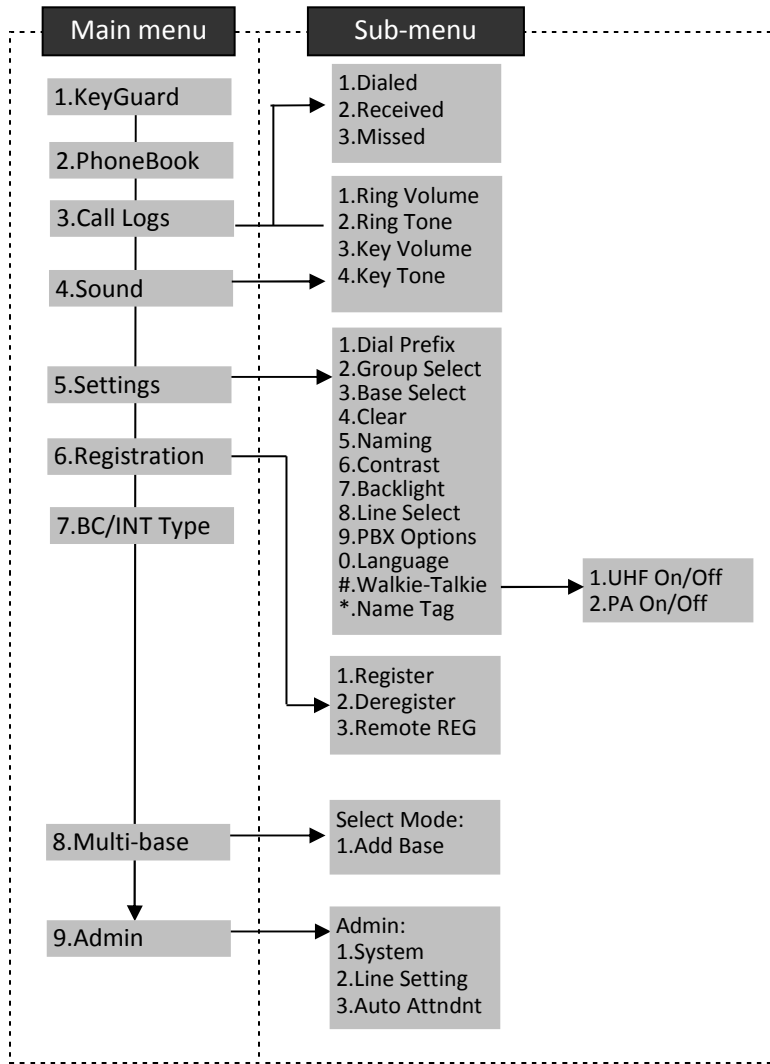



Menu Tree (Register to PRO base only)



Making a Telephone Call

1. Press , wait for dial tone, and then enter phone number.

~31~

2. Alternatively, you can enter phone number first then press  key. When using this method, you can use the **CLEAR** (Left) and **DELETE** (Right) soft keys to edit the number entered. "Delete" erases the last digit entered. "Clear" erases the entire line but remains in the dialing mode.
3. **Speed dial** by access the entries in the phone book
 - a. Press  or  scrolling key to enter the phone book
 - b. Press  to dial out the number
4. To abort dialing, press  key.
5. During the call, press the  key to activate the speakerphone.

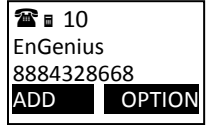



Notes:

1. After a link established, the Base ID will appear on the upper-right corner. If no Base ID shown up, it applied that you are approaching the boundary of the coverage.
2. If the line is occupied, the LCD shows "No Line Available" and handset returns to standby mode.
3. If a link cannot be established, the LCD will show "No Base" after a 12-second time out.
4. A call duration timer will start displaying the length of the call after link is established.

Making an 2-Way/ Intercom Call

The EnGenius Industrial Cordless Phone System offers private, Intercom/ 2-way radio calls independence of base station. Intercom/ 2-way communication can be placed from or to base stations and handsets.

A. Handset to Handset Calls

1. Press  key followed by a two-digit handset ID or Group ID.
2. Press  key to end the call.

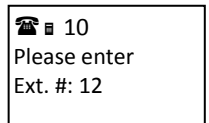

~32~

3. During the call, press the  key, the speakerphone is active.

Notes:

8. Intercom calls can be made regardless if the Base Station is present.
9. If a Group ID is entered, the first handset (belonging to that group) that answers will establish a link with the caller. See Handset Group Subscription.
10. If a link cannot be established, the LCD shows “No Connection” after a 12-second time out.

Making a Broadcast via 900MHz

A. Handset to Handset Calls

1. Since the SPR-922U1 is able to broadcast the handsets via 900MHz (as PRO did) or UHF band, you have to choose the desired frequency for walkie-talkie operation before doing a broadcast. Enter the key sequence **MENU** - 5 - # - 1, then select “OFF” to enable the WT mode in digital 900MHz band. After press “End” to back idle mode. You can see the display without walkie icon.

- a. Press and hold “PTT” key from one handset
- b. Hear bi-bi-beep while the initiating handset broadcast all handsets within communication coverage
- c. Start to speak the message to be broadcasted once you hear the “beep” sound; the speakerphone of destination handsets will be opened up
- d. Release “PTT” key to end the broadcasting

2. Broadcasting a group of handsets
 - a. Enter the Group ID and then press “PTT” key
 - b. Hear bi-bi-beep while the initiating handset broadcast all handsets within communication coverage

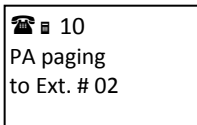

- c. Start to speak the message to be broadcasted once you hear the “beep” sound; the speakerphone of destination handsets will be opened up
- d. Release “PTT” key to end the broadcasting

3. Broadcasting an individual handset
 - a. Enter the Handset ID and then press “PTT” key
 - b. Hear bi-bi-beep while the initiating handset broadcast all handsets within communication

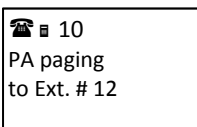

coverage

- c. Start to speak the message to be broadcasted once you hear the “beep” sound; the speakerphone of destination handsets will be opened up
- d. Release “PTT” key to end the broadcasting

Making a Broadcast via UHF

A. Handset to UHF walkie-talkie

1. Activate walkie-talkie mode
 - a. Enter the key sequence **MENU** - 5 - # - 1, then select “ON” to enable the WT mode in analog UHF band. After press “End” to back idle mode. You can see the display with a walkie icon.
2. Broadcasting all UHF walkie-talkie handsets
 - a. Ensure the same setting for channel/Frequency/Code before doing the broadcast
 - b. Press “PTT” key, the display will show channel and transmitting a broadcast to all handsets within communication coverage
 - c. Start to speak the message to be broadcasted immediately; the speakerphone of destination handsets will be opened up
 - d. Release “PTT” key to end the broadcasting

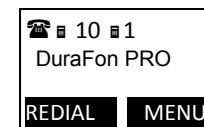

Scanning via UHF

The Scan feature is to check continuously for activity on the channels. You should activate which channels desired to scan in walkie programming mode. You can scan up to 5 channels as settings. When the radio detects activity, it stops scanning and locks it on the active channel.

1. Enter programming mode via pressing and hold MODE key while turning the radio on. Press “MODE” key 6 times to enter the scan channel setting. You can use “Up” or “Down” key to select which channel to be scanned
2. Press “Left” soft key to enable/disable this channel scanning
3. Press “END” key to exist the setting.

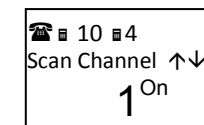

To begin scanning:

- During IDLE mode, press and hold the “MODE” key for 3 seconds to start the scan. the radio begins to scan the channel. You can see the scan icon and rolling channel number.

When the radio detects activity, it stops scanning till without signal.

- You can rotate knob clockwise to increase and counterclockwise to decrease volume

To stop scanning:

- During IDLE mode, press and hold the “MODE” key for 3 seconds to end the scan.

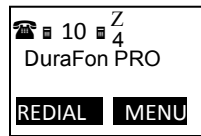

Monitoring via UHF

You can use monitoring feature to check the activity on the channel. The squelch will be opened to unmute the speaker; you can check another party is using the same channel.

To begin scanning:

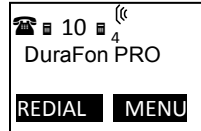

- During IDLE mode, press and hold the  key for 3 seconds to start monitoring the current channel. You will hear static and show receiving icon on display



To stop scanning:

- press and hold the  key for 3 seconds to end the monitor.



Redial

- Press **REDIAL** (Left) soft key.
- The LCD shows the last phone number dialed. To dial this number, press **DIAL** (Left) soft key.
- Use  or  Arrow Key to scroll through the last 10 phone numbers dialed. Select and press **DIAL** soft key.
[Note] Intercom numbers (Handset ID) are not stored in the last 10 numbers dialed log.

Receiving a Telephone Call

- When an incoming call arrives, the ringer will ring or vibrate unless the ringer



has been turned off.

- If the handset is on the charger cradle (ringer will be temporarily switched to “Ring” if it has been set to “Vibrate”), lift the handset and start conversation.
- If the handset is not on the cradle, press any key (except , and the Silent soft key) to answer.
- During the call, press the  key, the speakerphone is active.

Notes:

- You can press **SILENT** (Left) soft key if you choose to ignore the call. Unlike turning off the ringer (from the handset menu), the **SILENT** key operation is valid only for the current call.
- If Caller ID service is available, the LCD will display the incoming call information. If the LCD shows “Private” or “Unknown”, the caller’s information may have been blocked by the caller or the originating phone company.

Receiving an Intercom Call

- When an intercom call arrives, the ringer will ring or vibrate unless the ringer has been turned off. Press  to answer the intercom call.
- If the handset is on the charger cradle (ringer will be temporarily switched to “Ring” if it has been set to “Vibrate”), lift the handset and start conversation.
- If the handset is not on the cradle, press any key (except , and the **SILENT** soft key) to answer.
- During the call, press the  key, the speakerphone is active.



Notes:

- The LCD displays the caller’s Handset ID.
- You can press the **SILENT** (Left) soft key if you choose to ignore the call. Unlike turning off the ringer the **SILENT** key operation is valid only for the current call.

Ending a Call

To end a telephone or intercom call, press  key or place handset into charger cradle.

Adjusting Voice Volume in Phone mode

1. Voice volume can only be adjusted during a call. It is used for receiver (earpiece) and speaker in phone.
2. There are 6 levels of volume selections. Default = 3. Use  or  arrow key to adjust
3. The new setting remains effective for all future calls until changed.

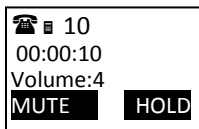

Adjusting Volume in Walkie-Talkie

1. The volume from speaker in walkie-talkie can only be adjusted by On-Off/Volume knob.
2. Rotate knob clockwise to increase and counterclockwise to decrease volume

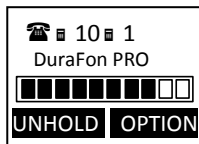

Placing a Call On Hold

1. When a call is in progress, it can be put on hold by pressing the **HOLD** (Right) soft key.
2. To return to the conversation, press **UNHOLD**

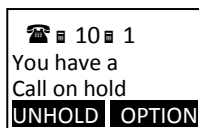

Notes:

1. The call being placed on hold can only be “un-hold” by the handset that puts it on hold.
2. Handset LCD displays a call is being on hold. An alert tone (double beep) every 30 seconds will remind the handset that a call is being on hold.
3. If the operation (e.g., call transfer) after putting a call on-hold fails, the held call may be dropped.
4. You can power off the handset (e.g., change battery) while call is on hold. After power on again, you can continue the call by pressing **UNHOLD** (Left) soft key to terminate the hold state.

Mute

1. After a link is established, you can press **OPTION** (Left) soft key and press “0” to mute the handset microphone.
2. When mute is active, the other end will not hear your voice, but still can speak to you.
3. To leave the mute state, press **UNMUTE** (Left) soft key. Mute is effective only for the current call.

Do Not Disturb (Silent Ring)

1. Enter the key sequence **MENU** - 4 - 1, then select “Off”. Press **SAVE** to confirm your choice. This will turn off the ringer until it is turn on again from the menu.
2. For temporary silencing the ringer when an incoming call arrives, press **SILENT** (Left) soft key.

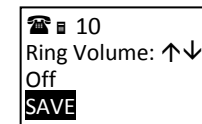
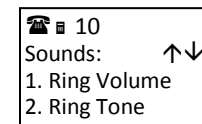

Key Guard

1. To prevent accidental dialing, you can press **MENU** (Right) soft key, then press “1” to select KeyGuard option. The handset keypad is locked. No key entry is accepted except the power on/off key.
2. To unlock the keypad, press **UNLOCK** (Left) soft key, then, within 2 seconds, press the digit “1” to unlock.
3. Key Guard is in effect until unlocked or powered off.

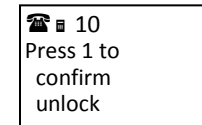

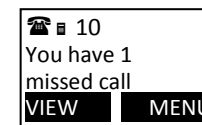

To View Missed Call(s)

1. Whenever you have missed incoming call(s), you can Press **VIEW** soft key to enter the call logs information.
2. You need to subscribe the caller ID service from local telecom company to retrieve this data.



To Call back from Call Log

- When you review missed incoming call(s), you can directly call back by pressing  key.
- The displayed CID number in most cases will be a 10-digit number with the 3-digit area code followed by the 7-digit telephone number. If the area code is unnecessary for calling back, you can follow below rule to adjust the calling back number:
 - Press **FORMAT** key once, the 3-digit area code will be removed.
 - Press **FORMAT** key twice, "1" will be added in front of the displayed number.
 - Press **FORMAT** key three times, it will loop back original displayed number.

Re:The CID default is 10 digits, when press **FORMAT** key, it will be 7-digit → 11-digit → 10-digit in circle.
- After the displayed number chosen, press the  key to call back.

Battery Recharge and Replacement

- Charge the battery when one or several of the following happen:
 - Phone beeps twice every two seconds.
 - Battery icon is empty.
 - Phone does not respond when a key is pressed.
 - LCD and backlighting become dim.
 - Talk range shortfall is experienced.
- You can replace the handset battery after placing the call-in-progress on hold.
- Battery talk time and standby time vary depending on the talk/standby pattern and the operating distance. Putting the handset back to charger cradle as often as possible is recommended for best performance. **Use only manufacturer provided battery and charger!**

Programming Mode in Walkie-Talkie

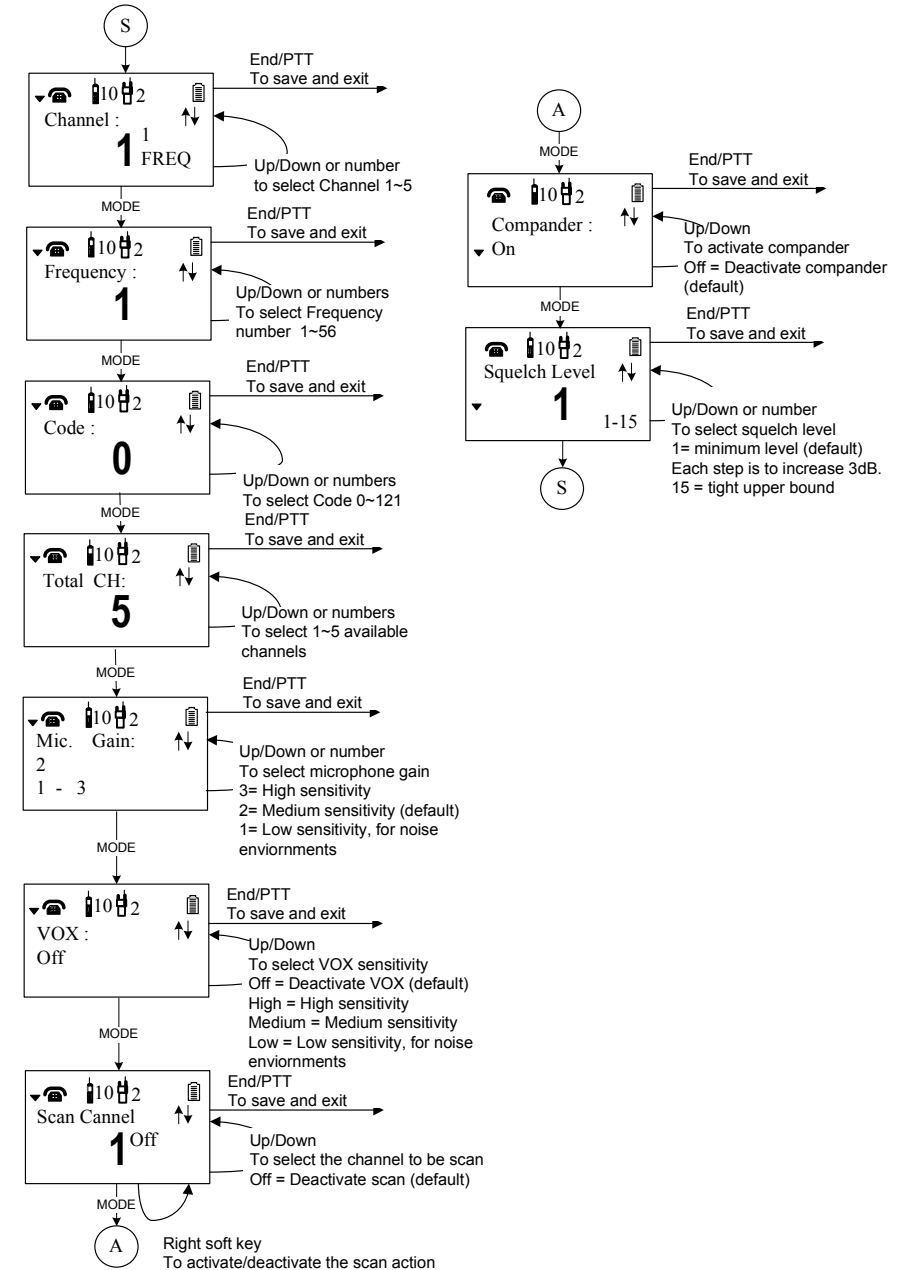

- To enter programming mode, press and hold MODE key while turning the radio on.
 - Press Up/Down key to scroll the channel selection, Channel 1 to 5 used for

UHF band, channel 6 used for digital band.

- b. Press Mode key to enter the desired frequency number setting. You can enter number key directly (1~56), or use up/down key to scroll the frequency number.
 - c. Press Mode key to enter the desired Code number setting. You can enter number key directly (0~121), or use up/down key to scroll the code number.
 - d. Press Mode key to program total 1~5 channels used.
5= Five channels available (default)
 - e. Press Mode key to set the desired microphone gain setting. Use up/down key to scroll the gain level(1-3).
3= High sensitivity
2= Medium sensitivity (default)
1= Low sensitivity, for noisy environments
 - f. Press Mode key to select VOX sensitivity setting which is only used for headset only. Use up/down key to scroll the VOX activate gain level(1-3).
3= High sensitivity
2= Medium sensitivity
1= Low sensitivity, for noisy environments
Off= Deactivate VOX(default)
 - g. Press Mode key to enter the scan channel setting
Use up/down key to scroll the desired channel.
Use left key to activate/deactivate the scan. "Off" display on the right side means to deactivate the scan (default).
 - h. Press Mode key to activate compander setting. When activated (default), transmitted signal are compressed before being sent and received signal are expanded when they arrive.
Use up/down key to deactivate/activate the compander.
 - i. Press Mode key to select the squelch level setting. Default value 1 is minimum level. Each step is to increase 3 dB threshold level.
2. Press "End" or "PTT" key to store and exit the Walkie-Talkie programming mode

Advanced Operations

Handset Registration (Register to PRO base only)

1. When 1st time using the handset, you need to register the handset to the base station (The handset ID is 00 before registering to the base station) .
 2. In certain situations, you may want to change a handset's ID. For example, you want to change a particular handset from a user to an administrator (ID 10 or 11), or vice versa. Or in some rare occasions, you find another handset having the same Handset ID.
 3. Registration
 - a. Press MENU-6 to enter the registration mode
 - b. Press and hold the base's Registration (REG) button for 2 seconds until 4 LEDs light up.
 - c. Press handset key "1", this completes the registration process. The base station will assign a handset ID between 10 and 99. The assigned ID will be displayed on the handset LCD, indicating successful registration.
 - d. Repeat above steps for all additional handsets.
 - e. The first two handsets registered will be given ID 10 and 11, which gives them administrator privileges.
- Re : Base 00 is a primary base. All handsets must register to Base 00.
4. De-registration:
 - a. You can de-register a handset from a base. De-registration will reset the Handset ID to 00, erase the system security code, and free up the old ID for future registration.
 - b. After deregistration, the handset will not be able to use the base to make or receive phone calls, nor can it use the intercom to reach other handsets.
 - c. Press handset **MENU** (Right) soft key.
 - d. Press the handset number key **6**, this will enter the handset registration menu.
 - e. Press and hold the base's **REG** button for 2 seconds until 4 LEDs come on LED come on
 - f. Press the handset number key **2**, this completes the de-registration process. Upon successful de-registration, the handset will show ID "00".

Notes:

1. The base has a 30 second registration timeout starting from pressing the **REG** button. The handset has a 12 second registration timeout starting from the time registration or de-registration option has been selected. The base and handset will automatically exit registration

mode after timeout.
 2. Repeat registration or de-registration process if unsuccessful.

Advanced Registration (Register to PRO base only)

1. Advanced registration functions can be performed by administrator handsets (ID 10 and 11) only.
2. Administrator handsets can perform advanced registration function as long as it is within range with the base station. The base station does not need to be in registration mode.
3. De-register a Handset ID by administrator:
 - a. Make sure that the administrator handset is within the coverage range of the base station.
 - b. Press administrator handset **MENU** (Right) soft key
 - c. Press the number **9**, this will enter the handset administration menu.
 - d. Press number **1**, handset enters system setting menu.
 - e. Press number **4**, and enter the two-digit Handset ID to be cleared.
 - f. Upon successful operation, the handset LCD will display “Done”, otherwise it will show “Message not received, try again”.
4. Obtain a Specific Handset ID:
 - a. If a particular Handset ID is preferred over sequentially assigned ID, the administrator can “tell” the base in advance what the next ID assignment should be.
 - b. Press administrator handset **MENU** (Right) soft key.
 - c. Press the number **9**, this will enter the handset administration menu.
 - d. Press number **1**, handset enters system setting menu.
 - e. Press number **5**, and enter the two-digit Handset ID to be assigned next by the base.
 - f. Upon successful operation, the handset LCD will display “Done,” otherwise it will show “Message not received, try again.”
 - g. If the handset ID is already in use by another handset, the administrator will be alerted. In that case, the administrator can choose another ID or asks the handset having the desired ID to vacate by de-registering with the base.
 - h. Perform registration immediately afterward for the handset desiring a specific ID to ensure that the ID is not taken by another handset.
5. Remotely register Handset
 - a. If base install in ceil or higher location, administrator handsets can perform remote registration.
 - b. Press administrator handset **MENU** (Right) soft key
 - c. Press the number **6**, this will enter registration mode.

- d. Press number **3**, this will replace the procedures to press & hold the base **REG** button until the 4 LEDs come on.
- e. Proceeding the handset registration process for new handsets.

Notes:

1. De-registration by the administrator will disable a handset’s ability to use the base station to make or receive phone calls. This also frees up the ID for future registration.
2. Handsets de-registered by the administrator can still perform intercom to other handsets.

Handset Group Subscription

1. Up to seven handset groups (01-07) can be defined and handsets can decide which group(s) they want to be in.
2. For example, Group 1 represents the Customer Service Group, Group 2 represents the Sales Group, and Group 3 is the Marketing Group. Suppose that Handset 11 wants to receive incoming rings for all Sales and Marketing related calls. Then handset 10 will need to “subscribe” to Group 2 and Group 3.
3. Group Selections:
 - a. Press handset **MENU**-5 to enter the handset setting menu
 - b. Press number “2”, handset enters group select menu.
 - c. Press **ADD** soft key and enter two-digit group number (01-09) to add membership in a group.
 - d. Repeat for all desired groups.
 - e. Delete group selections by pressing **DELETE** key and enter group number.

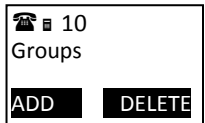
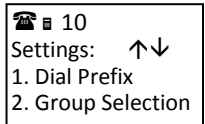

Notes:

1. The handset can change group affiliations at any time.
2. The base (administrator) is not responsible for group assignments. Consequently, it cannot de-subscribe a handset from a group.

Call Transfer (Register to PRO base only)

1. While a telephone call is in progress, you can place the call on hold and transfer the call.



handset must be in range with the direct base station.

2. Press **HOLD** soft key to put call on hold.
3. Press **OPTION** soft key to enter feature list for selection.
4. Press number **2** and enter a two-digit Handset ID to call another handset extension.
 - a. Un-announced Call Transfer:
Press **END** before the destination handset answers, the call is automatically transferred to the destination handset.
 - b. No support Announced Call Transfer in DuraFon PSL-BU

Notes:

1. If the destination handset does not answer after handset paging timeout, the call is routed back to the originating handset.
2. Above described "Call Transfer" is for DuraFon PRO handset-to handset call transfers.

Base Select (Register to PRO base only)

1. A handset can manually select the desired base station before access outbound line.
2. Press handset **MENU** (Right) soft key.
3. Press the number **5**, this will enter the handset setting menu.
4. Press number **3**, handset enters Base Select setting mode.
5. Use  or  arrow to scroll up and down the selection on/Off.
6. Make a selection (default =off), and press **SAVE** (Left softkey).
Re: When turns on the Base Select, you must enter 2-digit Base ID after press  key.

Notes:

1. Because this setting allows handset manually select the base station, the

Visual Message Waiting Indicator (VMWI)

VMWI feature is supported via FSK message signaling when received from the phone company telephone line or PBX system; It will activate a message icon on the handset display and flash the VOICE MESSAGE LED on the base.

Notes:

1. A subscription to the telephone company voice mail service is required.
2. If the handset still indicates the icon even after you have listened to all messages, turn it off by pressing and holding the "Caller ID" key on the handset.

Line Dedication (Register to PRO base only)





1. Line dedication function can be performed by administrator handsets (ID 10 and 11) only.
2. By default all incoming calls will ring all handsets.
3. With the administrative handset, press **MENU-9-2-2** for Line Dedication setting.
4. It will first show Line 1 and line status. If you wish to dedicate line 1 to a specific handset or group, you need to press **CHANGE**. For DuraFon PSL-BU base, you don't need to set line2-4 related setting.
5. After choosing a line, it will show **YES** and **NO**, when choosing **YES**, you need to enter the handset ID or group ID for extension number. If you choose **NO**, it will go back to Line Setting menu.

Notes:

1. When entering Line Dedication setting, it will show line and status. If line is already dedicated to a specific handset or group, it will show the handset or group ID behind the line. If line isn't dedicated to a specific handset yet, it will show "ALL HS" behind the line.
2. When setting Line Dedication, make sure the handset or group ID is correct to avoid losing calls sent to an DuraWalkie handset or invalid ID.
3. Handsets dedicated to a port will also receive calls from non-dedicated line as well as the handset's dedicated line. Use Line Dedication for a group on other lines to further manage calls

Line Selection (Register to PRO base only)

1. Press **MENU - 5 - 8** while the phone is in standby to enter Line Select menu.

2. Use  or  to switch between **On** and **Off**, default = Off.
3. If set to On, when pressing  or entering a phone number followed by pressing  key, the handset LCD display will show "Select Line" followed by available lines (1~4). Select from one of the available lines i.e. press **1** to select line 1 and press **2** to select line 2. For DuraFon PSL-BU base, you should press **1** only.

Change System and Line Settings by Administrator (Register to PRO base only)



1. There are two system parameters that can be changed by the administrator: clear (de-register) handset ID and set the next handset ID to be assigned by the base.
2. From an administrator handset (Handset 10 or 11), press **MENU**(Right) soft key.
3. Press number **9**, this will enter the administration menu.
4. Press number **1**, handset enters System setting menu.
 - a. Dial tone:
Press **1** to set up the dial tone to be either "Tone" or "Pulse." Press **1** to choose "Tone" or press **2** to choose "Pulse."
 - b. Flash time:
Press **2** to set up the flash time from 100ms, 200ms, to 900 ms (9 levels to choose from.) For example, press **2** if the desired flash time is 200ms.
 - c. Line Detect:
Press **3** to set up the line detect to be either "On" or "Off." Press **1** to choose "On" or press **2** to choose "Off." For DuraFon PSL-BU base, no support Line Detect. The setting is invalid.
 - d. Clear Handset ID
Press **4** and enter a two-digit Handset ID when prompted to clear this ID for later assignment.
 - e. Set next Handset ID to be assigned:
Press **5** and enter a two-digit Handset ID when prompted. This is the ID that will be given out by the base to the next handset registering with the base.
5. Press number **2**, handset enters Line Setting menu.
 - a. Enter Base ID(00~07) to access base.
 - b. Press **1** to enter Broadcast setting
 - i. Press handset **OFF**(Right softkey) to disable broadcasting function;
 - ii Or press handset **ON**(Left softkey) to enable broadcasting function
 - c. Press **2** to enter Line dedication setting

- i Select base's line and press handset **CHANGE**(Right softkey)
- ii Line Dedicate confirm:
Press **NO**(Right softkey) to go back Line Setting Menu.
Press **YES**(Left softkey) then enter extension number.



Note:





De-registration by the administrator will disable a handset's ability to use the base station to make or receive phone calls. This also frees up the ID for future registration

Phonebook Operations









1. You can store up to 90 entries in the phonebook. Each entry can contain a phone number or handset ID (up to 28 digits) and a name (up to 14 characters).
Re: For DuraWalkie, each entry can store 2 digits handset ID or Group ID.
2. To access phonebook, press **MENU** followed by **2** or  or  scrolling key when handset in standby mode.
3. To add a new entry:
 - a. Press **ADD** soft key.
 - b. Enter a phone number when LCD prompts "Number?" Use **DELETE** soft key to delete the last digit entered. Press **SAVE** when completed.
 - c. You will then be prompted to enter a name for the phone number just entered.
 - (1) Press **SAVE** key to enter a phone number without a name. All records without a name will be placed on top of the list, in the order they are entered.
 - (2) To enter the name, press the corresponding keypad number one or more times according to the order of the character on the key.
 - (3) Use **DELETE** soft key to delete the last character entered. When completed, press **SAVE** soft key to confirm your selection.

Notes:



1. When entering a phone number, the cursor automatically advances to the next digit field. Use  or  scrolling key to move the cursor backward or forward to insert or delete.
2. When entering a name, the cursor automatically advances to the next

character field if you press a different key for the next character. If you need to enter consecutive characters from the same key, you can wait for the cursor to advance or use  or  scrolling key to move the cursor backward or forward manually. Also use  or  to move the cursor to insert or delete.



3. By default, all letters are entered in the upper case. Use the ***** key to toggle between upper and lower cases.
4. A "Pause" entry represents a 2.8 second delay in dialing the following digits, which is useful when calling a sequence of segmented numbers (e.g., access code, credit card number, auto-attendant entries, etc.) Pause is entered by pressing the ***** key twice (LCD displays P). Entering pause twice (PP) will result in 5.6 seconds pause in the dialing.

4. The entries are alphabetically sorted and stored as a list in an ascending order (A to Z) from the top of the list.
 - a. If the phonebook is entered from the menu, the first entry displayed is from the top of the list.
 - b. If the phonebook is entered using the , the first entry displayed is from the top of the list.
 - c. If the phonebook is entered using the , the first entry displayed is from the bottom of the list.
5. The first line of LCD display shows name and the 2nd line shows the phone number. If the phone number is longer than 14 digits, press **OPTION** soft key and select Option 3 to view the complete number.
6. To search for a record:
 - a. Use  or  scrolling key to enter the Phone Book mode.
 - b. Press a key that corresponds to the first character of the name you are looking for.
 - c. For example, you are looking for "EnGenius", and then press the number **3** once.
 - d. Use  or  scrolling key to locate the exact record you are looking for.
7. To erase phonebook entry:
 - a. Use  or  scrolling key or the alphabetical search method to locate the record to be erased.
 - b. Press **OPTION** soft key to enter editing menu.
 - c. Press **1** to erase the designated phone entry.
 - d. LCD shown "Are you sure?" Press **YES** to double confirm

your change.

8. To edit phonebook entry:
 - a. Use  or  scrolling key or the alphabetical search method to locate the record to be edited.
 - b. Press **OPTION** soft key to enter editing menu.
 - c. Press **2** to edit the designated phone entry.
9. Dial from display:
 - a. Press **TALK** or Intercom to dial the phone number or Handset ID displayed.
10. To transfer phonebook:

To transfer phonebook, both parties have to enter the phonebook transfer mode firstly by following below:

 - a. Press **OPTION** follow by **4** or  or  scrolling key when handset in phonebook mode.
 - b. For phone sending party, press **1** to enter sending mode.
 - i. Either press **TX ALL** (left softkey) to transfer all phonebook entries to another handset(s).
 - ii. Or press **TX ONE** (right softkey) to transfer one entry to another handset(s).
 - iii. Press 2-digit handset ID or group ID, then select all phonebook entries or one entry to be transferred.
Re : "00" means all handsets
 - iv. During phonebook transferring, LCD shows "Sending" and 2-digit countdown on the LCD to indicate the phonebook numbers which are waiting for sending.
 - c. For phonebook receiving party, press **2** to enter receiving mode.
 - i. When entering the receiving mode, LCD shows "Ready".
 - ii. Start to receive phonebook, LCD shows "Get phonebook from Ext. # : xx".
 - iii. A beep emitted when receiving each phonebook.
 - iv. When the phonebook receiving, 2-digit countdown on the LCD to indicate the phonebook numbers which are waiting for receiving.

Re: The phonebook transfer through the wireless interface, it may partially miss transmission by interference

Notes:

Character Table:

Key	Characters and Orders
1	' + , . * () & 1
2	A B C 2
3	D E F 3
4	G H I 4
5	J K L 5
7	P Q R S 7
8	T U V 8
9	W X Y Z 9
0	0
*	Toggle case when in character editing * P (Pause) when in number editing
#	Space – when in character editing # when in number editing

Programmable PBX Options (Register to PRO base only)

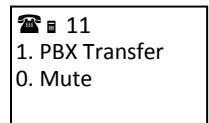
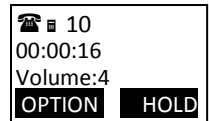
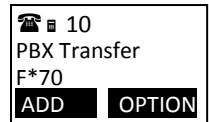
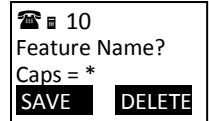
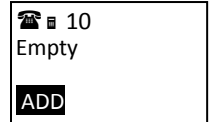
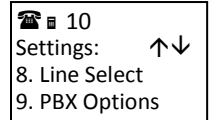

- When DuraFon PRO base unit installed behind the PBX system, it is feasible to pre-program some PBX features along with their feature codes into the system.
- Up to 9 most frequently used PBX feature codes can be pre-programmed.
- Name and enter PBX feature codes:
 - Press **MENU** (Right) soft key while the handset is in standby.
 - Press “5” following by “9” to enter “PBX Options” menu.
 - Press **ADD** soft key to edit a PBX feature to be memorized.
 - Key in the name of the PBX features just like editing a phonebook entry i.e. PBX Transfer. Press **SAVE** to confirm your entries.
 - Key in the feature code of the correspondence PBX feature i.e. Flash*70. Press **SAVE** to confirm your entries.
 - The first PBX feature and the correspondence feature code you enter will appear on the LCD screen.
[note] “F” represents the Flash signal
 - Press **OPTION** soft key to Erase or Edit the PBX feature you program into the system.
 - Repeat the same operation to edit the second and even the third PBX feature that you will use frequently.
- Using pre-programmed PBX feature during the call.
 - Press **OPTION** soft key while the handset is in talk mode .
 - Press the correspondence number of the function you want to perform i.e. press 1 to perform “PBX Transfer” function.
 - Press  when you finish the desired function and back to standby mode.



Notes:

1. This feature would be useful if the DuraFon PRO base unit is adjunct to a PBX system.
2. Only "Mute" function will be displayed if you have not preprogrammed any PBX features into the system.
3. The DuraFon PRO's Programmable PBX Options may not function with all PBX / Key systems due to the diversity of various proprietary systems.

Repeater Operation

1. Due to the range performance of handset to handset calls (intercom or broadcast) isn't as good as line calls, in order to get better range performance for handset to handset calls, install a repeater and make the calls via repeater is the solution.
2. The procedure of repeater's registration is same as the multi-base which can be performed by administrator handset (Handset 10 and 11).
3. From an administrator handset (Handset 10 or 11), press **MENU** – **7** to enter the "BC/INT Type" menu setting.
4. Press  or  key to select "Repeater Mode", then press **SAVE** (Left softkey) to confirm the selection.
Re : When setting to "Repeater" mode, the handset to handset calls will always via repeater.
5. Enter the base number (00~07) which assigned the base to be a repeater.
6. The default of "BC/INT Type" is "P2P Mode".

Notes:

- a. The repeater must work with PRO system.
- b. A repeater can only support 2 simultaneous intercom calls (2 pairs handsets).
Or can only support 1 broadcast call.

• Intercom

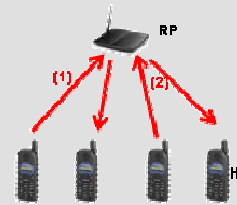

• Broadcast (PA)

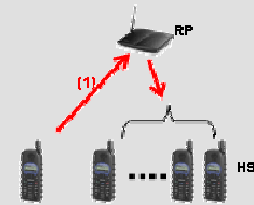

- c. In order to operate with a PRO system, the repeater must be assigned a base ID from the PRO system, please refer to the multi-base setup to add the repeater as a multi-base.
- d. The handsets which intend to work with the repeater require enabling a "Repeater Mode".
- e. When enabling the "Repeater Mode", both intercom and broadcast calls will go via the repeater, instead of the original direct handset to handset (P2P mode).
- f. A repeater will no longer support any PSTN call.
- g. No support put the repeaters in cascade.
- h. When using a repeater, if the repeater is busy or not available, after time out period (broadcast: 8 sec, intercom : 40 sec) the call will be convert to "P to P" instead.

UHF Frequencies and Codes

- 1 These frequency display number is same as Motorola CLS/CPL frequency position. Each bandwidth is used 12.5KHz.

Display Number	Frequency (MHz)
1	464.5000
2	464.5500
3	467.7625
4	467.8125
5	467.8500
6	467.8750
7	467.9000
8	467.9250
9	461.0375
10	461.0625
11	461.0875
12	461.1125
13	461.1375
14	461.1625
15	461.1875
16	461.2125
17	461.2375
18	461.2625
19	461.2875

Display Number	Frequency (MHz)
20	461.3125
21	461.3375
22	461.3625
23	462.7625
24	462.7875
25	462.8125
26	462.8375
27	462.8625
28	462.8875
29	462.9125
30	464.4875
31	464.5125
32	464.5375
33	464.5625
34	466.0375
35	466.0625
36	466.0875
37	466.1125
38	466.1375

Display Number	Frequency (MHz)
39	466.1625
40	466.1875
41	466.2125
42	466.2375
43	466.2625
44	466.2875
45	466.3125
46	466.3375
47	466.3625
48	467.7875
49	467.8375
50	467.8625
51	467.8625
52	467.9125
53	469.4875
54	469.5125
55	469.5375
56	469.5625

- 2 These interference eliminator codes display number is same as Motorola CLS/CPL. Display number 0 disables interference elimiator codes.

Display Number	Code (Hz)
1	67.0
2	71.9
3	74.4
4	77.0
5	79.7
6	82.5
7	85.4
8	88.5
9	91.5
10	94.8
11	97.4
12	100.0
13	103.5

Display Number	Code (Hz)
14	107.2
15	110.9
16	114.8
17	118.8
18	123.0
19	127.3
20	131.8
21	136.5
22	141.3
23	146.2
24	151.4
25	156.7
26	162.2

Display Number	Code (Hz)
27	167.9
28	173.8
29	179.9
30	186.2
31	192.8
32	203.5
33	210.7
34	218.1
35	225.7
36	233.6
37	241.8
38	250.3





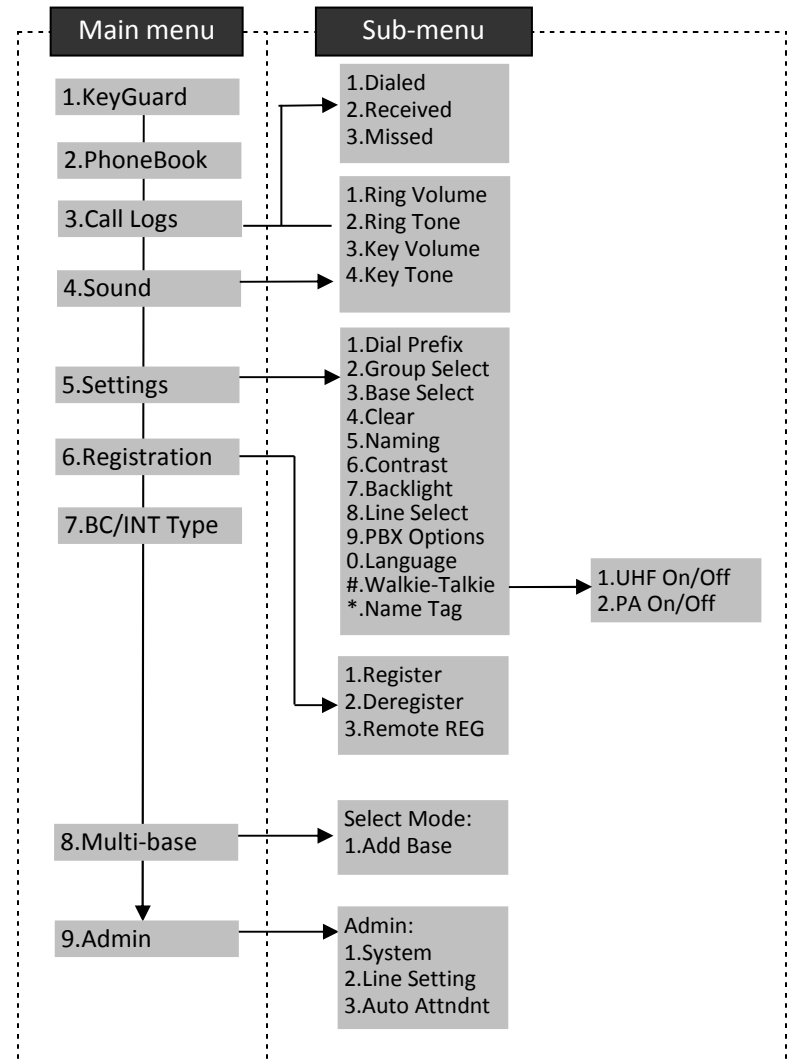

Display Number	Digital Code
39	023
40	025
41	026
42	031
43	032
44	043
45	047
46	051
47	054
48	065
49	071
50	072
51	073
52	074
53	114
54	115
55	116
56	125
57	131
58	132
59	134
60	143
61	152
62	155
63	156
64	162
65	165
66	172

Display Number	Digital Code
67	174
68	205
69	223
70	226
71	243
72	244
73	245
74	251
75	261
76	263
77	265
78	271
79	306
80	311
81	315
82	331
83	343
84	346
85	351
86	364
87	365
88	271
89	411
90	412
91	413
92	423
93	431
94	432

Display Number	Digital Code
95	445
96	464
97	465
98	466
99	503
100	506
101	516
102	532
103	546
104	565
105	606
106	612
107	624
108	627
109	631
110	632
111	654
112	662
113	664
114	703
115	712
116	723
117	731
118	732
119	734
120	743
121	754

Menu Operations (Register to PRO base only)























1. Press **MENU** (Right) soft key while the phone is in standby.
2. Press **1** to lock keypad (see Key Guard).
3. Press **2** to view, search, erase, edit and transfer the phonebook (see Phonebook).
4. Press **3** to view the last 10 numbers called, received, or missed. Records can be erased or edit/save into the phonebook.
 - a. Press **1** to view the last 10 phone numbers dialed, starting from the most recent one. Use  or  to scroll through the list.
 - i. Press **OPTION** (Right) soft key for options.
 - Press **1** and confirm to erase the current record.
 - Press **2** to edit and save or save without editing into the phonebook.
 - Press **3** to view the complete number if the phone number is longer than 14 digits.
 - b. Press **2** to view the last 10 phone numbers received, starting from the most recent one. Use  or  to scroll through the list.
 - i. Press **OPTION** (Right) soft key for options.
 - Press **1** and confirm to erase current record.
 - Press **2** to view the arrival date and time of the call.
 - Press **3** to edit and save or save without editing into the phonebook.
 - c. Press **3** to view the last 10 phone numbers received but not answered, starting from the most recent one. Use  or  to scroll through the list.
 - i. Press **OPTION** (Right) soft key for options.
 - Press **1** and confirm to erase current record.
 - Press **2** to view the arrival date and time of the call.
 - Press **3** to edit and save or save without editing into the phonebook.
 - d. The two-digit index on the upper right corner of the LCD display shows the location in ascending order, with 01 being the most recent call.
 - e. While viewing any of the three call logs, press **DIAL** (Left) soft key to dial the phone number.

Notes:

1. Only phone numbers are stored in the three call logs. Intercom calls are not recorded.

2. Caller ID service is required from your local phone company in order to receive phone numbers, names and time stamps on incoming calls. The Received and Missed Call Logs will register no incoming calls if Caller ID service is not available.
3. The Caller ID feature may not be supported by all PBX or Key systems' analog ports, check with your equipment provider

5. Press **4** to set sound-related settings:
 - a. Press **1** to select ringer volume: Use  or  to scroll through 6 options: Low, Medium, High, Vibrate, Vib and Ring, Off. Press **SAVE** (Left) soft key to save selection. Default = High.
 - b. Press **2** to select ringer tone: Use  or  to scroll through 4 options: 0, 1, 2, and 3. Press **SAVE** (Left) soft key to save selection. Default = 0.
 - c. Press **3** to select key volume when a key is pressed: Use  or  to scroll through 3 options: High, Low, and Off. Press **SAVE** (Left) soft key to save selection. Default = Low.
 - d. Press **4** to select key tone: Use  or  to scroll through 4 options: 0, 1, 2, and 3. Press **SAVE** (Left) soft key to save selection. Default = 0.
6. Press **5** to change handset settings:
 - a. Press **1** to set dialing prefix:
 - i. Use  or  to scroll and select to turn on or off the dialing prefix feature. Default = Off.
 - ii. If "On" is selected, the handset is prompted to enter a prefix, up to 14 digits.
 - iii. Use **DELETE** (Right) soft key and  or  to edit prefix.
 - iv. When this feature is turned on, the LCD will prompt the user on each outgoing phone call except during redial or dialing by pressing the  key first whether to use the dialing prefix. The current prefix is also displayed. Press **YES** (Left) or **NO** (Right) soft key to add the prefix to the beginning of the number.
 - v. This feature is useful for access code, calling card, and credit card calls, etc.
 - b. Press **2** to Group Select: see Handset Group Subscription
 - c. Press **3** to set or turn Base Select on or off. Default = Off. See Base Select.
 - d. Press **4** to clear call logs and phonebook:
 - i. Press **1** and confirm to delete the entire phonebook.

- ii. Press **2** and confirm to clear the three call logs (Called, Received, and Missed).
- e. Press **5** to edit the name of Custom or Line:
 - e-1. Press **1** to change the power-up LCD display to show, e.g., customer name or other greeting message:
 - e-2. Press **2** to change the name of line, when calls coming, it will indicate the calls came from which line.
 - i. Use  or  to move the cursor backward or forward to insert (to the left of the cursor) or delete (the character above the cursor, or left of the cursor if cursor is on the right of the last character).
 - ii. Enter characters using the Character Table and method discussed in the Phonebook section.
 - iii. When finished, press **SAVE** (Left) soft key to save change.
- f. Press **6** to change LCD display contrast:
 - i. Use  or  to scroll through values **1 to 8**. Pick one that is most suitable to you. Default = **6**.
 - ii. Press **SAVE** (Left) soft key to save setting.
- g. Press **7** to change the LCD backlight:
 - i. Use  or  to scroll through options: On, Off, and 20 Seconds. Default = 20 seconds, meaning that the backlight on, will turn off after 20 seconds of inactivity.
 - ii. Press **SAVE** (Left) soft key to save setting.
- h. Press **8** to change the Line selection:
 - i. Use  or  to scroll through options: On or Off. Default = Off, meaning that you can not select the other available lines to dial.
 - ii. Press **SAVE** (Left) soft key to save setting.
- i. Press **9** to change the PBX options:
 - i. Press **ADD** soft key to edit a PBX feature to be memorized and key in the name of the PBX features just like editing a phonebook entry.
 - ii. Press **SAVE** (Left) soft key to save setting.
 - iii. Press **OPTION** and **1** following by entering PBX options mode, you can erase the PBX option.
 - iv. Press **OPTION** and **2** following by entering PBX options mode, you can edit the PBX option.
 - v. Press **OPTION** and **3** following by entering PBX options mode, you can transfer the PBX options to other handset(s).

Re: To transfer PBX Options, both parties have to enter the PBX Option mode firstly by following below:
 For sending party, press **1** to enter sending mode.

 - Either press **TX ALL**(left softkey) to transfer all PBX options to another handset(s).



- Or press **TX ONE**(right softkey) to transfer a specific entry to another handset(s).
- Press 2-digit handset ID or group ID, then select all PBX options or a specific entry to be transferred("00" means all handsets)
- During PBX options transferring, LCD shows "Sending", and 2-digit countdown on the LCD to indicate the numbers of PBX options which are waiting for sending.

For receiving party, press **2** to enter receiving mode.

- When entering the receiving mode, LCD shows "Ready".
- Start to receive PBX options, LCD shows "Get PBX options from Ext. # : x mmm x".
- When the PBX options is receiving, 2-digit countdown on the LCD indicates the number of PBX options which are waiting to be received.

Note:

1. Different PBX makers use different analog codes to control PBX function, like call transfer, call park, etc.; Please refer to your PBX maker's manual for this information.
2. Errors may occur in PBX options and phonebook entries transferred wirelessly due to interference. Please re-enter entry manually if problems occur with a entry.

- j. Press **0** to change Language:
 - i. Use  or  to scroll through options: English and Portuguese. Default = Portuguese, meaning the LCD display shows in English.
 - ii. Press **SAVE** (Left) soft key to save setting.
- K. Press **#** to set Walkie-Talkie operation
 - K.1 Press **On** to enable/disable PTT key for UHF walkie-talkie(WT)
 - i. Press **On** (Left softkey) to turn on the UHF WT function which could receive and transmit the broadcast via UHF band.
 - ii. Press **Off** (Left softkey) to turn off the UHF WT function. The PTT key is used for digital band.
 - K.2 Press **Off** to turn Broadcast On/Off
 - i. Press **On** (Left softkey) to turn on the broadcast function (including the broadcast of handset to handset and base to handset).
 - ii. Press **Off**(Left softkey) to turn off the broadcast function

Re: When broadcast setting “Off”, there is an icon indicated in the display, side of the battery icon.

L. Press ***** to turn Name Tag On/Off.

i. Press **On** (Left softkey) to turn on the name tag function, when receiving the incoming calls, the LCD will show the name which stored in phonebook.

ii. Press **Off**(Left softkey) to turn off the name tag function.

7. Press **6** to register or de-register handset: See Handset Registration.

8. Press **7** to set up the intercom or broadcast via repeater(see Repeater Setup).

9. Item **8** is to add new bases.

From an administrator handset (Handset 10 or 11) to set new Base 01~07. Maximum additional bases is up to 8. Before adding a new base, the Handset must be registered in master base(Base ID =00).

a. Press **REG** button on new Base.

b. Use Handset 10 or 11 to Add base: Press **MENU**→ **8**→**1**

c. Enter 01~07 (base ID)

10. Press **9** to change system and Line setting: See System and Line Setting.

Technical Specifications

General Specifications	Base Station	Portable Handset	
		Phone Mode	Walkie-Talkie Mode
Frequency Range	902 ~ 928 MHz	902 ~ 928 MHz	461 ~ 469.5 MHz
Channel Number/Capacity	50	50	4
Channel Spacing	400 kHz	400 kHz	12.5 kHz
Number of System ID	65,535	65,535	NA
PL Codes	NA	NA	38
DPL Codes	NA	NA	83
Multiple Access	Frequency Hopping TDMA	Frequency Hopping TDMA	FDMA
Duplex	Time Division Duplex (TDD)	Time Division Duplex (TDD)	Half Duplex
Frequency Hopping Rate	100 per second	100 per second	NA
TDD Frame Length	10 ms	10 ms	NA
Number of Slots/Frame	8	8	NA
Channel Coding	8kbps Convolutional + CRC	8kbps Convolutional + CRC	NA
User Data Rate	128 kbps Duplex	128 kbps Duplex	NA
Antenna Gain	2 dBi 5 dBi External (optional)	2 dBi	0 dBi
Antenna Connector	Reverse TNC	Reverse SMA	
Average Battery Life	NA	90 hours (Walkie Off)	27 hours (5/5/90)
Power Source	100~240V/12V AC/DC Adapte	3.7V/2300 mAh Li-Ion Battery	
Charge Current	NA	850 mA	
Charge Time	NA	4 hours	
Regulation Compliance	FCC Part 15 FCC Part 68 RSS-247 CS03	FCC Part 15 FCC Part 68 RSS-247 CS03	FCC Part 90
Operating Temperature	0 – 50 °C	-10 ~ +60 °C	
Charging Temperature	NA	0 ~ +40 °C	
Storage Temperature	-10 – 70 °C	-40 ~ +70 °C	
Humidity	20 % ~ 75 %	0 % ~ 95 %	
IP Rating	NA	IP55	
Dimensions without Antenna (H x W x D)	188 x 161 x 42 mm	142 x 60 x 38mm	
Weight	424 g	256.5 g	

Notes:

1. NA = Not Applicable.
2. The manufacturer reserves the right to change designs and specifications without notice.

Index

2	Handset Charging Slot, 21
	Handset Features, 14, 16
3	Handset Group Subscription, 38, 60
A	Handset ID, 14, 27, 29, 30, 36, 37, 39, 42, 43, 44, 52
	Handset Registration, 22, 35, 63
	Handset to Handset Calls, 26
	Hearing Aid, 4
B	I
	idle mode, 23
	K
	Key Guard, 32, 59
	Key tone, 18
	L
	Line Dedication, 44, 45
	Line Indicator, 14
	Line Selection, 45
C	M
	Monitoring, 15, 28
	Multiple handsets registration, 16
	P
	Phonebook, 46
	Programming, 28, 34
	R
	Registration, 36
	Regulatory Information, 7
	REN, 66
	Repeater Operation, 53
	Ringer, 15
	RSSI, 14
	S
	Safety Instructions, 4, 6
	scan, 27
	scanning, 16, 27, 28
	Speaker phone, 14
	T
	Technical Specifications, 64
	Three Call Logs, 17
	To Call back from Call Log, 32
	To View Missed Call(s), 32
	Two-Digit Address Index, 14
	V
	Vibrator, 16

FCC Part 68 Statement

This equipment complies with Part 68 of the FCC rules and the requirements adopted by the ACTA. On the bottom of DuraFon PRO base station is a label that contains, among other information, a product identifier in the format US: [SNIW402A922PSLBU](#). If requested, this number must be provided to the telephone company.

Applicable connector jack Universal Service Order Codes ("USOC") for the Equipment is RJ11C.

A plug and jack used to connect this equipment to the premises wiring and telephone network must comply with the applicable FCC Part 68 rules and requirements adopted by the ACTA. A compliant telephone cord and modular plug is provided with this product. It is designed to be connected to a compatible modular jack that is also compliant. See installation instructions for details.

The REN is used to determine the number of devices that may be connected to a telephone line. Excessive RENs on a telephone line may result in the devices not ringing in response to an incoming call. In most but not all areas, the sum of RENs should not exceed five (5.0). To be certain of the number of devices that may be connected to a line, as determined by the total RENs, contact the local telephone company. For products approved after July 23, 2001, the REN for this product is part of the product identifier that has the format US: [SNIW402A922PSLBU](#). The digits represented by 0.2 are the REN without a decimal point (*e.g.*, 02 is a REN of 0.2).

If this SPR922U1 causes harm to the telephone network, the telephone company will notify you in advance that temporary discontinuance of service may be required. But if advance notice isn't practical, the telephone company will notify the customer as soon as possible. Also, you will be advised of your right to file a complaint with the FCC if you believe it is necessary.

The telephone company may make changes in its facilities, equipment, operations or procedures that could affect the operation of the equipment. If this happens the telephone company will provide advance notice in order for you to make necessary modifications to maintain uninterrupted service.

If trouble is experienced with this SPR922U1, for repair or warranty information, please contact:

Company: EnGenius Technologies

Address: 1580 Scenic Avenue, Costa Mesa, CA92626

Tel no.: 888.735.7888 ext. 827

If the equipment is causing harm to the telephone network, the telephone company may request that you disconnect the equipment until the problem is resolved.

Connection to party line service is subject to state tariffs. Contact the state public utility commission, public service commission or corporation commission for information.

If your home has specially wired alarm equipment connected to the telephone line, ensure the installation of this equipment does not disable your alarm equipment. If you have questions about what will disable alarm equipment, consult your telephone company or a qualified installer.

WHEN PROGRAMMING EMERGENCY NUMBERS AND(OR) MAKING TEST CALLS TO EMERGENCY NUMBERS:

- 1) Remain on the line and briefly explain to the dispatcher the reason for the call.
- 2) Perform such activities in the off-peak hours, such as early morning or late evenings.

Industry Canada statement:

This device complies with ISED's licence-exempt RSSs. Operation is subject to the following two conditions: (1) This device may not cause harmful interference, and (2) this device must accept any interference received, including interference that may cause undesired operation.

Le présent appareil est conforme aux CNR d'ISED applicables aux appareils radio exempts de licence. L'exploitation est autorisée aux deux conditions suivantes : (1) le dispositif ne doit pas produire de brouillage préjudiciable, et (2) ce dispositif doit accepter tout brouillage reçu, y compris un brouillage susceptible de provoquer un fonctionnement indésirable.

Radiation Exposure Statement:

The product comply with the Canada portable RF exposure limit set forth for an uncontrolled environment and are safe for intended operation as described in this manual. The further RF exposure reduction can be achieved if the product can be kept as far as possible from the user body or set the device to lower output power if such function is available.

Déclaration d'exposition aux radiations:

Le produit est conforme aux limites d'exposition pour les appareils portables RF pour les Etats-Unis et le Canada établies pour un environnement non contrôlé. Le produit est sûr pour un fonctionnement tel que décrit dans ce manuel. La réduction aux expositions RF peut être augmentée si l'appareil peut être conservé aussi loin que possible du corps de l'utilisateur ou que le dispositif est réglé sur la puissance de sortie la plus faible si une telle fonction est disponible.

For body-worn operating conditions please use belt-clips, holsters, and/or accessories that have no metallic component in the assembly and must provide at least 1.5cm separation between the device and the user's body.

Pour les conditions d'exploitation portés sur le corps s'il vous plaît utiliser des clips de ceinture, les étuis et / ou accessoires qui ont aucun composant métallique dans l'assemblage et doit fournir au moins une séparation de 1.5cm entre le dispositif et le corps de l'utilisateur.